



BVT200/225 Series

VersaTorr BVT200/225

1×10^{-6} to 1333 mbar / 7.5×10^{-7} to 1000 Torr

Ultra-wide range pirani / capacitance / piezo transducer
with atmospheric switch function

The VersaTorr BVT200/225 Series transducer establishes new standards with an all-in-one wide range measurement solution for a wide selection of vacuum applications. It differentiates from any other vacuum gauges by offering an overall cost-effective gas independent measurement from 5.0×10^{-3} to 1333 mbar in combination with measurement down to 1×10^{-6} mbar by use of the heat-loss principle.

In vacuum applications where the gas composition or type can change, traditional gas dependent Pirani gauges will result in measurement deviation from the actual pressure. The Tri Sensor transducer uses a precision capacitance diaphragm gauge (CDG) sensor that eliminates the gas dependency and provides accurate measurements also when the gas properties change.

The integrated heat-loss MEMS Pirani sensor extends the measuring range down to 1×10^{-6} mbar and provides a novel automatic zero adjustment of the capacitance manometer that eliminates the common needs for manual zero adjustment of traditional capacitance diaphragm gauges.

Features & Benefits

- Ultra-wide measuring range of 9 decades
- 6 decades of gas independent measurement from 5×10^{-3} to 1333 mbar
- Automatic zeroing of capacitance manometer
- 0-10 VDC programmable voltage output
- Digital RS-232 or RS-485 interface
- Vacuum temperature sensor for diagnostics
- RGB LED color pressure indicator

[View BVT200/225
Product Page](#)

BROOKS[®]
INSTRUMENT

Beyond Measure

Rethink vacuum gauging

The Tri Sensor is a novel true multi-sensor vacuum gauge and is the choice for superior performance upgrade of traditional Pirani gauge applications or a cost optimized all-in-one solution for applications where separate capacitance manometers and Pirani gauges are used.

Contamination containment

Particulate contamination can occur in applications like vacuum furnaces and physical vapor deposition systems. The optional baffle accessory can prevent such particles from reaching the sensor element and thereby extend the time between maintenance and overall lifetime of the product.

The baffle can be removed for contamination inspection, cleaning, or replacement.



Programmable settings and parameters

The transducer settings and parameters can be user-programmed to control vacuum system and application process parameters.

The digital RS-232 or RS-485 serial interface can be used for diagnostics, predictive maintenance, service, calibration, setpoint configuration, analog output scaling and acquisition of real-time vacuum pressure measurements for on-screen visualization.

The serial USB programmer in combination with the free, intuitive configuration software is a plug-and-play solution for transducer programming, real-time measurements, and diagnostics.

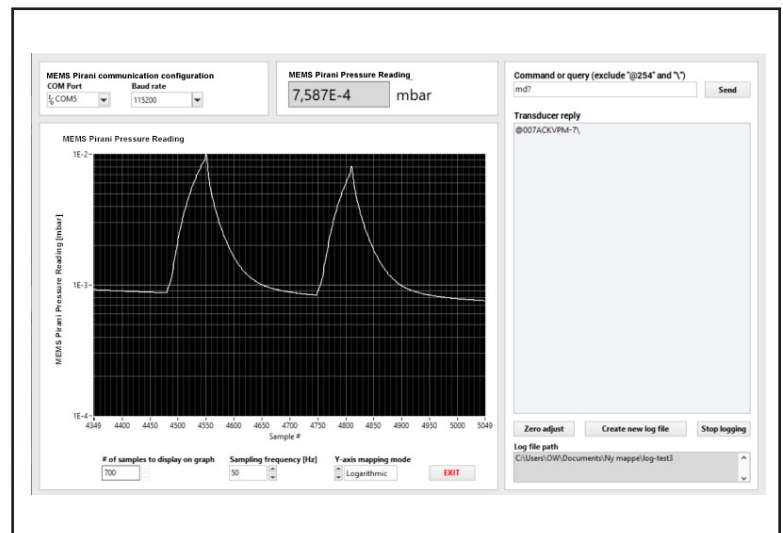

Reliable and robust setpoint relay control

The three independent solid-state switch relays can be used for external control of pumps, valves, safety interlock circuits and other external equipment. The basic control uses on/off regulation with a programmable setpoint and hysteresis value. Each solid-state relay offers both normally closed and normally open contacts.

Compared to electro-mechanical relays, the solid-state relays offer superior reliability and faster switching time while providing arc free contacts and generating no EMI (electromagnetic interference) when switching contacts.

The MEMS Pirani relays are designed to last and are UL listed, CSA recognized, and EN/IEC 60950-1 certified for maximum confidence when used to control critical vacuum processes and high-cycle applications.

Analog voltage output

The analog output can be user-configured via the UltraStable Zero-point or RS-232/RS-485 interface to any arbitrary scaling in the range 0-10 VDC. The analog output scaling feature enables amplified signal in a limited pressure range. Furthermore, a wide selection of analog output scaling options to emulate other vendors vacuum gauges and transducers is available.

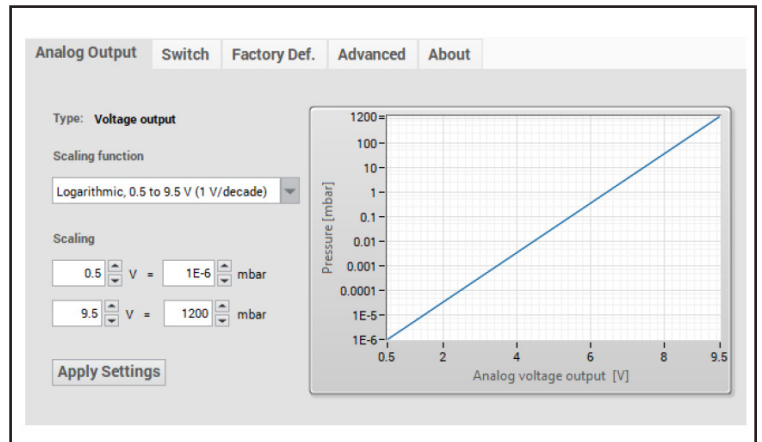

RGB LED for pressure indication

The VersaTorr Series introduces a new approach for visually determining the measured pressure by a multi-color LED that smoothly changes color throughout the pressure range. This selectable visual function is a low-cost alternative to integrated displays and provides a rough indication of the measured pressure. It also provides a clear visual warning if the vacuum system is pressurized above ambient pressure.

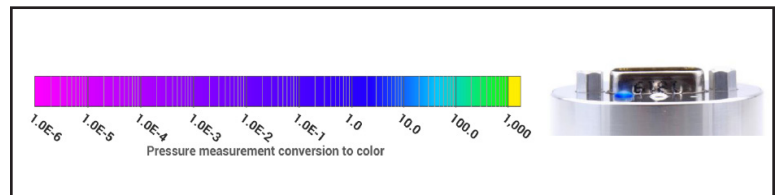

Customized settings

The transducer can be delivered with a custom configuration to match specific application requirements. Examples of pre-configured options include measurement range, vacuum pressure unit, setpoint configuration and output signal scaling. Customized products will be assigned a unique part number for easy and simple future reordering.

	BVT200	BVT225
SPECIFICATIONS		
Measuring range	1×10 ⁻⁶ to 1,333 mbar (7.5×10 ⁻⁷ to 1000 Torr)	
Measuring principle 1×10 ⁻⁶ to 1×10 ⁻³ mbar	MEMS Pirani thermal conductivity	
Measuring principle 1×10 ⁻³ to 4.99×10 ⁻³ mbar	Blended MEMS Pirani / piezo reading ⁽¹⁾	
Measuring principle 5.0×10 ⁻³ to 3.99 mbar	Capacitance diaphragm gauge (CDG)	
Measuring principle 4 to 6 mbar	Blended MEMS Piezo / CDG ⁽¹⁾	
Measuring principle 6 to 1333 mbar	MEMS piezo resistive diaphragm	
Accuracy 1×10 ⁻⁵ to 9.99×10 ⁻⁵ mbar	25% of reading	
Accuracy 1×10 ⁻⁴ to 9.99×10 ⁻³ mbar	5% of reading	
Accuracy 1E-2 to 800 mbar	0.5% of reading	
Accuracy 800 to 1099 mbar	0.25% of reading	
Accuracy 1100 to 1200 mbar	0.5% reading	
Barometric measurement range	300 to 1200 mbar	
Barometric accuracy	-	+/- 0.5 mbar
Atmospheric referenced pressure output range	-	-1333 to + 1333 mbar
Vacuum temperature sensor range	-20 to + 85°C	
Vacuum temperature sensor accuracy	+/- 1.5 °C	
Transducer temperature sensor range	-	-20 to + 85°C
Transducer temperature sensor accuracy	-	+/- 1.5 °C
Analog output resolution	16 bit (150 µV)	
Analog output update rate	124 Hz	
Response time	<20 ms	
Temperature compensation	+10 to +50 °C	
Solid state relay set point range (absolute)	5×10 ⁻⁶ to 1,333 mbar (3.75×10 ⁻⁶ to 1000 Torr)	
Solid state relay set point range (atm. relative)	-1,100 to + 500 mbar (-770 to +375 Torr)	
Solid state relay contact rating	50 V, 100 mA _{RMS} / mA _{DC}	
Solid state relay contact endurance	Unlimited (no mechanical wear)	
Solid state relay approvals	UL Recognized: File E76270 CSA Certified: Certificate 1175739 EN/IEC 60950-1 Certified	

	BVT200	BVT225
ENVIRONMENT CONDITIONS		
Operating ambient temperature	-20 to +50 °C	
Media temperature	-20 to +50 °C	
Storage ambient temperature	-20 to +50 °C	
Bake-out temperature (non-operating)	+80 °C	
Maximum media pressure	4 bar absolute	
Mounting position	Arbitrary	
Protection rating, EN 60529/A2:2013	IP40	
Humidity, IEC 68-2-38	98%, non-condensing	
POWER SUPPLY		
Supply voltage	12-30 VDC	
Power consumption	350 mW (max)	
Reverse polarity protection	Yes	
Overvoltage protection	Yes	
Internal fuse	100 mA (thermal recoverable)	
MATERIALS		
Enclosure	SS 1.4307 / AISI 304L / Aluminum 6061	
Vacuum Process flange (media wetted)	SS 1.4307 / AISI 304L	
Vacuum exposed materials (media wetted)	304 Stainless steel, Kovar, glass, silicon, nickel, aluminum, SiO ₂ , Si ₃ N ₄ , Al ₂ O ₃ , gold, Viton®, low out-gassing epoxy resin, solder, RO4305	
Process leak tightness (ISO 27895:2009)	<1·10 ⁻⁹ mbar·l/s	
APPROVALS		
CE	EMC directive 2014/30/EU	
RoHS compliance	Directive EU 2015/863	

(1) Blending range can be changed and application adapted via the digital interface.

Dimensions (DN16KF flange)

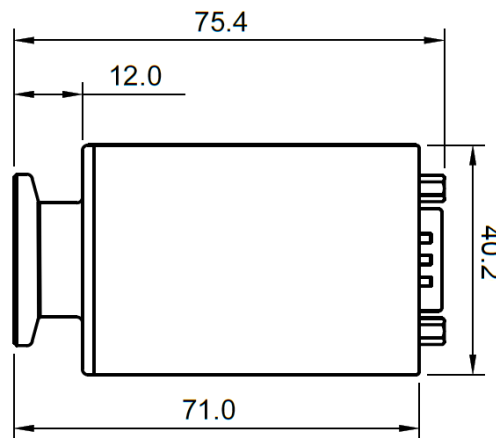

All dimensions in mm.

Connector Pin Outs

BVT200/BVT-225 15 Pin HD D-sub RS-232 / RS-485

Pin	Description
1	RS-232 Transmit / RS-485 (-)
2	RS-232 Receive / RS-485 (+)
3	Supply voltage 12-30 VDC
4	Supply voltage - (return)
5	Analog voltage signal +
6	Analog voltage signal - (return)
7	Relay 1 NO (normally open contact) ⁽¹⁾
8	Relay 1 Common ⁽¹⁾
9	Relay 1 NC (normally closed contact) ⁽¹⁾
10	Relay 2 NC (normally closed contact) ⁽¹⁾
11	Relay 2 Common ⁽¹⁾
12	Relay 2 NO (normally open contact) ⁽¹⁾
13	Relay 3 NC (normally closed contact) ⁽¹⁾
14	Relay 3 Common ⁽¹⁾
15	Relay 3 NO (normally open contact) ⁽¹⁾

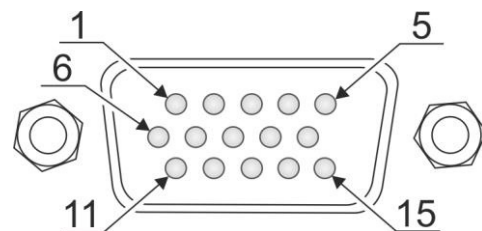

(1) Optional relay

BVT200 9 Pin D-sub RS-232 / RS-485

Pin	Description
1	Relay 1 NO (normally open contact) ⁽¹⁾
2	Relay 1 NC (normally closed contact) ⁽¹⁾
3	Supply voltage 12-30 VDC
4	Supply voltage – (return)
5	Analog voltage signal +
6	Relay 1 Common ⁽¹⁾
7	RS-232 Transmit / RS-485 (-)
8	Analog voltage signal – (return)
9	RS-232 Receive / RS-485 (+)

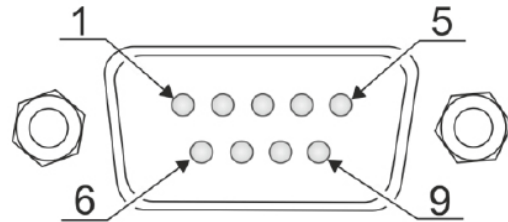

(1) Optional relay

BVT200 6 Pin Hirschmann connector

Pin	Description
1	Identification resistor (3K)
2	Analog voltage signal +
3	Analog voltage signal – (return)
4	Supply voltage 12-30 VDC
5	Supply voltage – (return)
6	Chassis

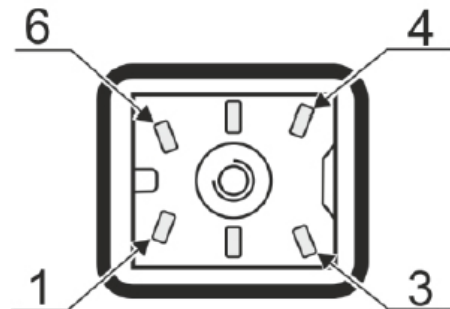

BVT200 8 Pin RJ45 / 8P8C

Pin	Description
1	Supply voltage 12-30 VDC
2	Supply voltage – (return)
3	Analog pressure voltage signal +
4	Analog pressure voltage signal – (return)
5	Supply voltage – (return)
6	Relay 2 NO (normally open contact) ⁽¹⁾
7	Relay 1 NO (normally open contact) ⁽¹⁾
8	Relay COMMON

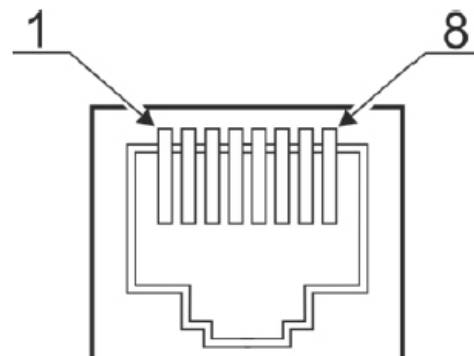

(1) Optional relay

Code Description	Code Option	Option Description		
I. Base Model	BVT200	VersaTorr Tri-sensor Transducer		
	BVT225	VersaTorr Tri-sensor Transducer w/ Barometer		
II. Units	1	Torr		
	2	mbar		
	3	Pascal		
III. Setpoints	0	None		
	1	1x Solid State Relay		
	2	2x Solid State Relay		
	3	3x Solid State Relay		
IV. Vacuum Flange			BVT200	BVT225
	1	DN16KF	x	x
	2	DN25KF	x	x
	3	NPT 1/8"	x	x
	4	VCR4	x	x
	5	DN16KF Extended	x	x
	6	DN16KF with light baffle	x	x
	7	DN16KF with heavy duty baffle	x	x
	8	DN25KF with light baffle	x	
	9	DN25KF with heavy duty baffle	x	
V. Electrical Connector			BVT200	BVT225
	1	9 Pin D-sub male	x	
	2	15 pin HD D-sub male	x	x
	3	15 pin HD D-Sub male / dual analog out	x	x
	4	6 pin Hirschmann, ID res 3K	x	
	5	6 pin Hirschmann, ID res 5.1K	x	
	6	6 pin Hirschmann, ID res 9.1K/11.1K	x	
	7	8 pin RJ45 / FCC68, ID Res 27K	x	
	8	8 pin RJ45 / FCC68, ID Res 36K	x	
	9	8 pin RJ45 / FCC68, ID Res 43K	x	
VI Digital Interface			BVT200	BVT225
	1	RS-232 / Brooks Vacuum Transducer Communicator	x	x
	2	RS-485 / Brooks Vacuum Transducer Communicator	x	x
	3	Brooks Vacuum Transducer Communicator	x	
VII. Analog Output	A	0.5 - 9.5 (1 V/dec)		
	B	1.0-9 VDC 1 VDC/Dec (MKS 901P/925/910)		
	C	0.375 to 5.659 VDC (MKS GP275)		
	D	1.0-9 VDC (MKS 523)		
	E	1.9-10 VDC (Inficon PSG55x, Leybold TTR91)		
	F	1.5-8.5 VDC (Pfeiffer TPR260/27x/28x)		
	G	1.9-9.1 VDC (Edwards APG100XLC)		
	H	1.9-9.1 VDC (Edwards APG100XM)		
	J	0-10 VDC 0.1Torr FS Capacitance manometer		
	K	0-10 VDC 1 Torr FS Capacitance manometer		
	L	0-10 VDC 10 Torr FS Capacitance manometer		
	M	0-10 VDC 100 Torr Capacitance manometer		
	N	0-10 VDC 1000 Torr Capacitance manometer		
	VIII. Customer Special Request	XXXX		

		BVT200	BVT225
Part number	Description		
BVT-XXX-(model number)	Accredited calibration certificate from DAkkS lab.	x	x
Brooks Vacuum Transducer Communicator USB programmer			
BVT-S4-15DS-01	Brooks Vacuum Transducer Communicator programmer USB, 15p HD D-sub connector	x	x
BVT-S4-9DS-01	Brooks Vacuum Transducer Communicator programmer USB, 9p D-sub connector	x	
BVT-S4-9DS-01	Brooks Vacuum Transducer Communicator programmer USB, 8p FCC68/RJ45	x	
BVT-S4-HM-01	Brooks Vacuum Transducer Communicator programmer USB, 6p Hirschmann	x	
RS232 / RS485 USB-to-Serial converter for BVT100 & BVT125 transducers			
BVT-RS2-15DS-01	RS232 communicator USB, 15p HD D-sub connector	x	x
BVT-RS4-15DS-01	RS485 communicator USB, 15p HD D-sub connector	x	x
BVT-RS2-9DS-01	RS232 communicator USB, 9p D-sub connector	x	
BVT-RS4-9DS-01	RS485 communicator USB, 9p D-sub connector	x	
Cables			
BVT-F15DSM15DS-003	15 p HD D-sub female to 15 p D-sub male with 3 m cable	x	x
BVT-F15DSM15DS-005	15 p HD D-sub female to 15 p D-sub male with 5 m cable	x	x
BVT-F15DSM15DS-010	15 p HD D-sub female to 15 p D-sub male with 10 m cable	x	x
BVT-F9DSM15DS-003	9 p D-sub female to 15 p D-sub male with 3 m cable	x	
BVT-F9DSM15DS-005	9 p D-sub female to 15 p D-sub male with 5 m cable	x	
BVT-F9DSM15DS-010	9 p D-sub female to 15 p D-sub male with 10 m cable	x	

Service and Support

Brooks is committed to assuring all of our customers receive the ideal flow solution for their application, along with outstanding service and support to back it up. We operate first class repair facilities located around the world to provide rapid response and support. Each location utilizes primary standard calibration equipment to ensure accuracy and reliability for repairs and recalibration and is certified by our local Weights and Measures Authorities and traceable to the relevant International Standards.

Visit www.BrooksInstrument.com to locate the service location nearest to you.

START-UP SERVICE AND IN-SITU CALIBRATION

Brooks Instrument can provide start-up service prior to operation when required. For some process applications, where ISO-9001 Quality Certification is important, it is mandatory to verify and/or (re)calibrate the products periodically. In many cases this service can be provided under in-situ conditions, and the results will be traceable to the relevant international quality standards.

CUSTOMER SEMINARS AND TRAINING

Brooks Instrument can provide customer seminars and dedicated training to engineers, end users, and maintenance persons. Please contact your nearest sales representative for more details. Due to Brooks Instrument's commitment to continuous improvement of our products, all specifications are subject to change without notice.

TRADEMARKS

BrooksBrooks Instrument, LLC
All other trademarks are the property of their respective owners.

PATENTS

Advanced Digital Architecture: 6,910,381; 7,010,983; 7,490,518
Digital Temperature Control: 6,701,790; 7,729,628
Improved Sensitivity to Temperature and Humidity: 6,734,659
Mark IV Sensor: 4,823,603



DS-VAC-BVT-200-225-eng/2022-02

Global Headquarters

Brooks Instrument
407 West Vine Street
Hatfield, PA
19440-0903 USA

Toll-Free (USA): 888-554-FLOW
T: 215-362-3500

BrooksAM@BrooksInstrument.com

A list of all Brooks Instrument locations and contact details can be found at www.BrooksInstrument.com

©Copyright 2022 Brooks Instrument, LLC All rights reserved. Printed in U.S.A.

BROOKS[®]
INSTRUMENT
Beyond Measure