



SolidSense II® Pressure Transducers

SolidSense II Pressure Transducers

Superior stability and reliability for demanding pressure measurement applications

The Brooks® SolidSense II® Pressure Transducers are designed for stable, accurate, and reliable pressure monitoring in high purity and ultra-high purity (UHP) applications. A combination of optimum design and materials improves both signal stability and reliability in numerous pressure measurement applications.

Pressure transducers are widely used in high purity and ultra-high purity fluid storage and delivery systems in many industries. Unfortunately, a number of current transducers rely on technologies that have problems with zero and span drift, thermal shift, and case stress. Adjusting the transducer to rectify errors requires ongoing maintenance that increases downtime and cost of ownership.

The third generation SolidSense II pressure transducers by Brooks Instrument utilize glass-fused strain gauge technology enabling a new level of performance for micro electronics and industrial applications.

SolidSense II pressure transducers employ ultra stable, micro machined silicon strain gauges that are matched and fused to the metal diaphragm at high temperature to relieve manufacturing induced stress. The process reduces drift or lack of zero stability commonly associated with competitive products. Consequently, down time for zero adjustment to compensate for drift is significantly reduced. In addition, the unique mechanical design eliminates torque effects during installation.

SolidSense II digital architecture enables automated software driven calibration and a wide range of thermal compensation routines, unlike the passive compensation used in competitive devices. This enhances measurement repeatability regardless of changes to the operational environment.

SolidSense II devices feature 316L stainless steel wetted surfaces electropolished to 5- and 10-micro in. (5- and 10-Ra) to maintain the purity of the measured fluid.

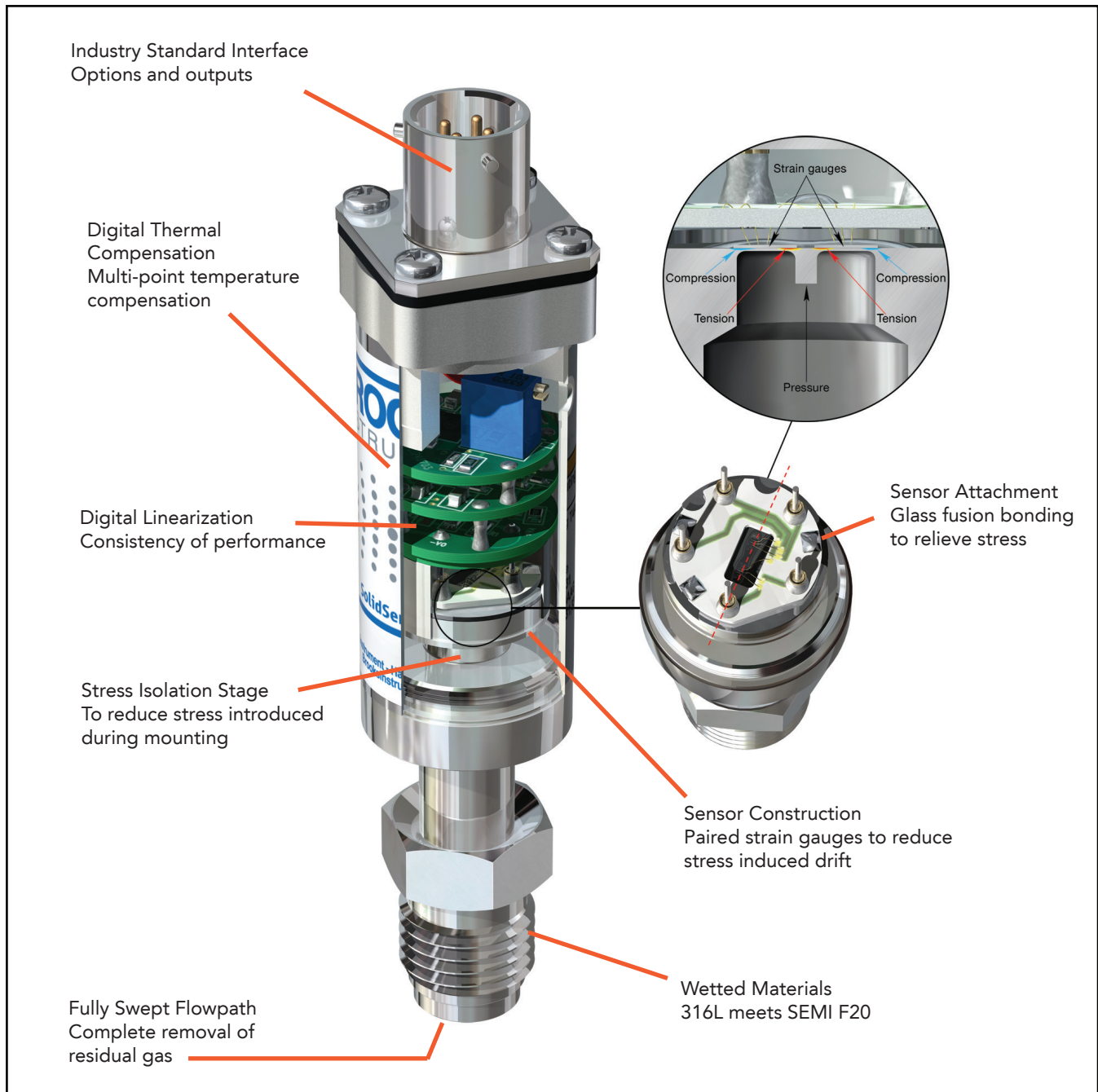

Features	Benefits
Two pairs of strain gauge sensors	Precision matched sensors for improved performance
Glass fusion process to bond strain gauge	High temperature glass bonding drives off any mechanically induced build up of stress from sensor manufacturing process
Stress isolation stage	Minimizes stress introduced during installation of the transducer
Digital temperature compensation	Improved thermal stability over entire range of temperature
Digital linearization and calibration	Consistency of performance, improved reproducibility
Fully swept flowpath	Ensures contamination-free pressure measurement
Integrated fully rotatable display option	Local indication of process pressure for safe system maintenance Compact with no special wiring for easy system integration/installation

Strain Gauges

SolidSense II utilizes proprietary micro machined silicon strain gauges that are ultra stable and suitable for high purity and ultra-high purity requirements.

A design feature for controlling stress is the use of dual paired gauges. By using two paired gauges in Wheatstone bridge circuitry, the pressure signal is maximized enhancing stability.

Sensor Attachment

A key step for eliminating machining stress in the diaphragm is the glass fusion process used to bond the strain gauges to the sensor diaphragm. This process occurs at 600°C and drives off any mechanically induced build up of stress resulting in a highly stable and accurate sensor.

By using silicon strain gauge technology and the glass fusion bonding method for Solid Sense II, there is no stress induced from thermal gradients between structural materials. In some competitive designs, different thermal expansion coefficients between the metal casing and ceramic electrode (upon which the sensor is mounted) allow for flexing of the sensor which is interpreted as a false pressure change.

Stress Isolation Stage

SolidSense II incorporates an isolation stage shown at right that minimizes stress from: (1) thermal heating during any adjacent welding and (2) torque during installation in gas panels, gas interface boxes, valve manifold boxes, etc. By preventing stress during these two scenarios, creep (drift) is eliminated during subsequent usage.

Fully Rotatable Display

This integrated display option reduces gas panel overall size constraints by eliminating the requirement for a standalone pressure gauge and reduces height by 2-6 inches. The display is fully rotatable - covering 4 quadrants - and no tools are required to set/secure the position. A bright LED display ensures readability in typical compact installation conditions. It provides exact visual feedback and verification of line pressure and an over pressure indication (roughly at 110% FS). The fully integrated display combined with the SSII high performance provides exact pressure measurement choice for field upgrades and new gas processing system designs.

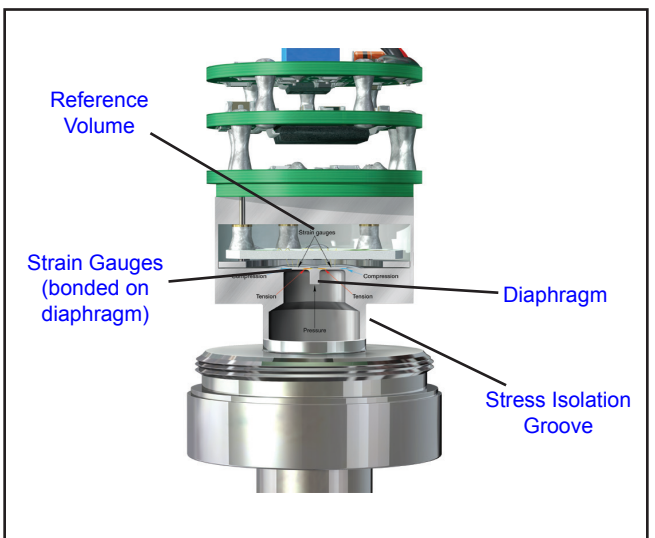
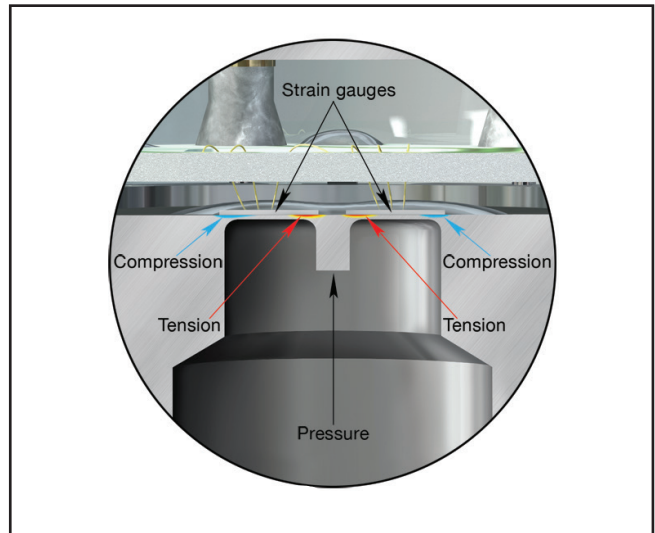
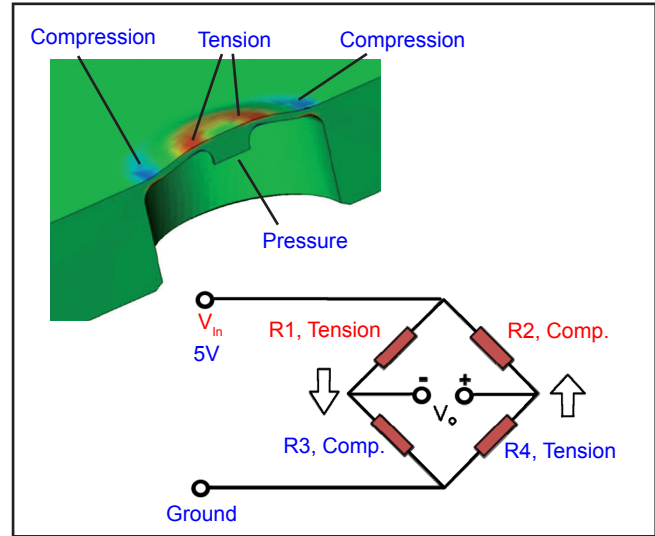

Digital Linearization and Calibration

SolidSense II is calibrated with automated software which uses about 200 linearization points compared with 2 for some competing units. This results in consistency of performance from one transducer to the next (reproducibility). Due to automation, operator induced differences are eliminated.

Digital Thermal Compensation

SolidSense II uses multi-point digital temperature compensation. Some competitive devices rely on single or two point compensation to optimize device performance over the operating temperature range. For example, device performance might be checked at -10°C and 60°C to determine the dZ/dT and dS/dT (rate of zero/span change per temperature change) with the temperature compensation interpolated for other values. SolidSense II can incorporate five separate data points, which are typically taken at -10°C, -5°C, 20°C, 40°C and 60°C, giving the temperature compensation algorithm far better resolution.

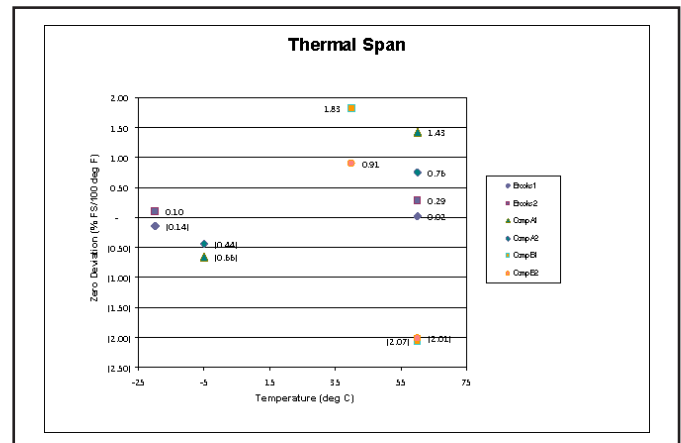
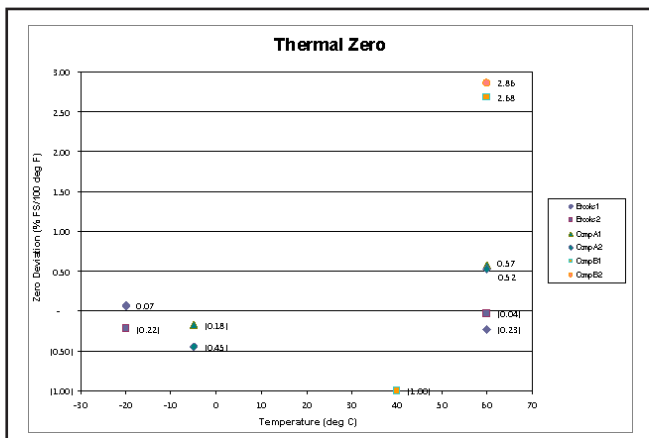

Fully Swept Flowpath

The SolidSense II incorporates an all-swept flowpath and very small internal volume allowing complete removal of residual fluid during the purge cycle. As a result inert, dry and clean surfaces are available at the end of the purge cycle.

ASTM F1397 establishes a dry-down requirement to 20 ppbv H2O within 30 minutes. As accompanying data shows, the dead end configuration of the SolidSense II recovered to desired level within 11.5 minutes and the flow thru configuration recovered in 9.5 minutes, both well below the requirement indicated in standard.

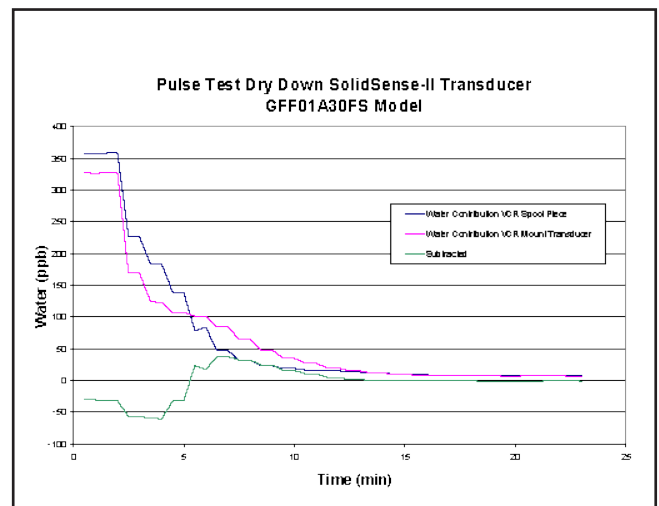
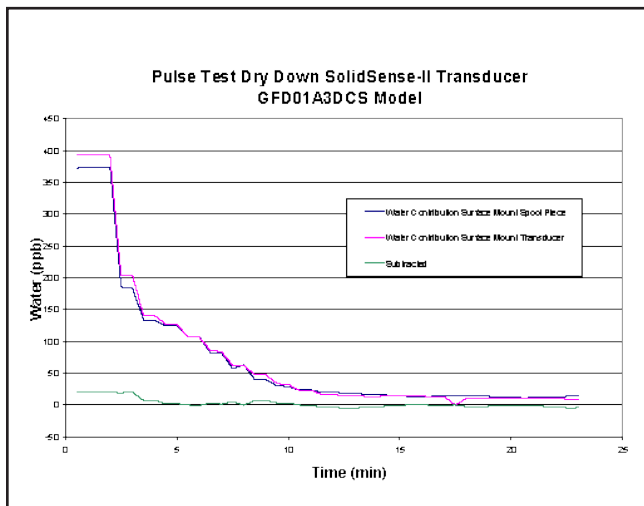

Robustness

The SolidSense II design incorporates a stress isolation stage. This prevents stresses built up during installation of transducers from being transmitted to diaphragm. As a result, SolidSense II will not require frequent resetting of zero after installation and in operation.

A number of applications involve subjecting the pressure transducer to rapid pressure cycling in a purge cycle. As shown in test results, SolidSense II will not temporarily indicate inaccurate pressure readings due to the Joule-Thompson effect. In some competitive devices this may cause false alarms and shut down the gas distribution system.

Zero Stability

Minimal drift, creep and shifts during installation and service life.

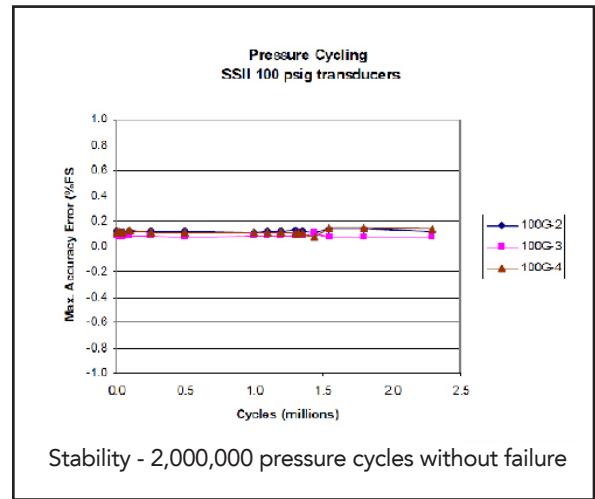
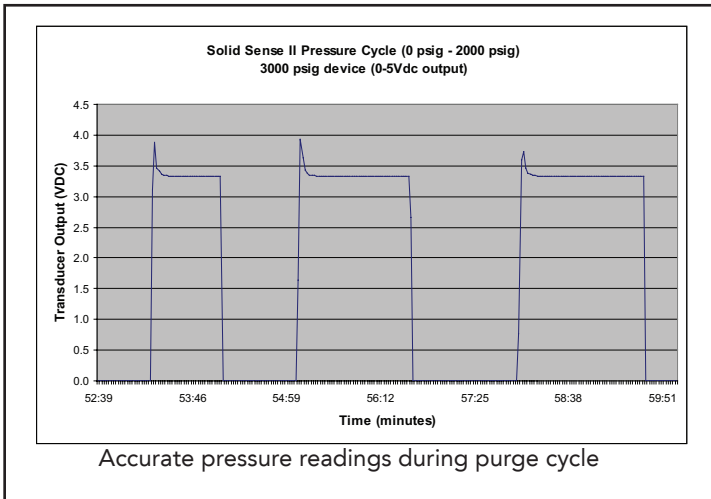

Metrology

Calibration system that is traceable to international primary standards with minimal uncertainty - precise dependable pressure measurements.

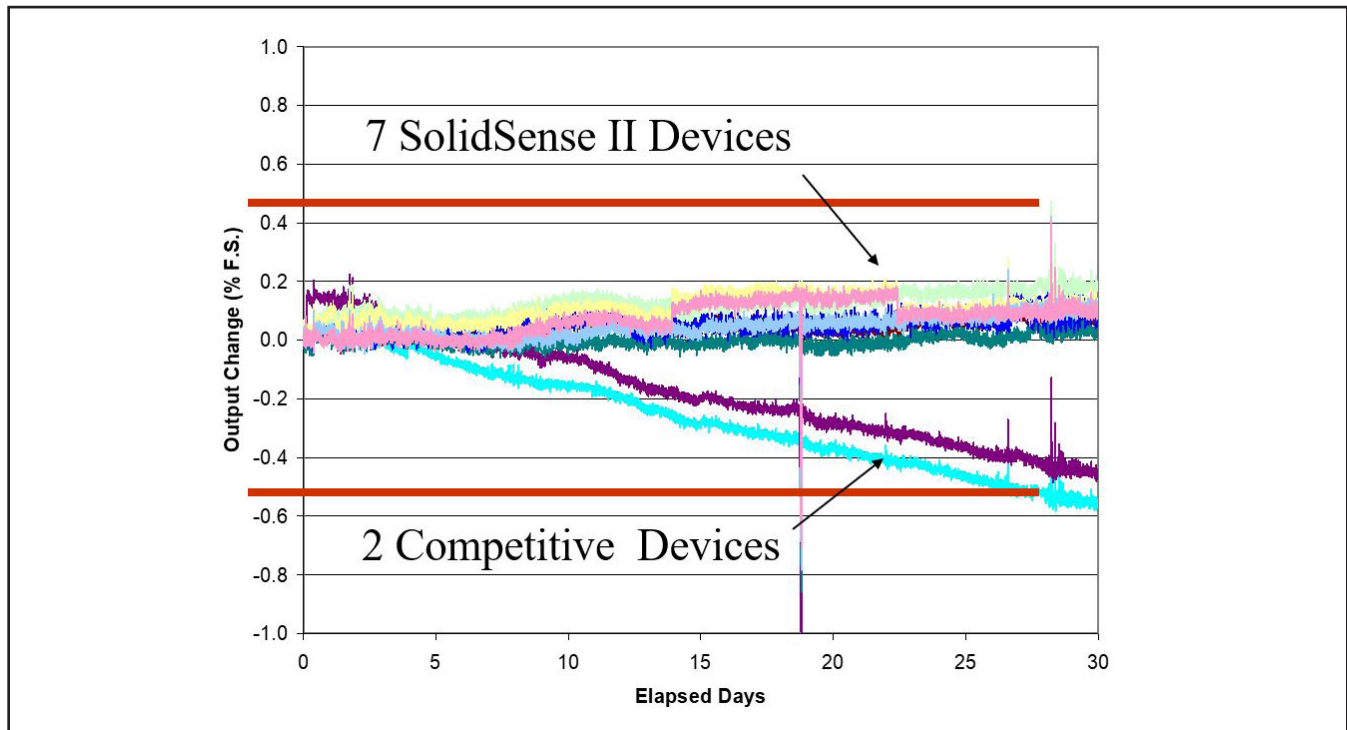

Semiconductor Manufacturing

Ultra-high purity gases and liquids are at the heart of semiconductor manufacturing operations. Their safe storage and distribution is vital to uninterrupted production. Gas cabinets, gas panels, valve manifold boxes and distribution valve boxes all require reliable pressure measurement of these fluids.

Several design features and manufacturing processes described in more detail elsewhere in this data sheet enable superior accuracy and long-term stability. Two are emphasized here:

The sensor isolation stage minimizes stress coupled from adjacent welding operations and torque from installation. By isolating stress during these two scenarios, stress-related creep or drift is eliminated. All gas cabinets are designed to handle purge cycles to facilitate safe changeover of cylinders. Whether these are automatic or manual, it is common to introduce a big surge in pressure followed by vacuum over very short period of time. Test results show that SolidSense II will not temporarily indicate inaccurate readings during purge cycles due to Joule-Thompson effect.

Measure build-up across filters

Many sanitary processes use filters to ensure product quality. As the load on the filter increases, a pressure differential between the inlet and outlet sides of the filter can be measured using SolidSense II. Once an established differential limit is reached, the filter can be preventively replaced before throughput goes down.

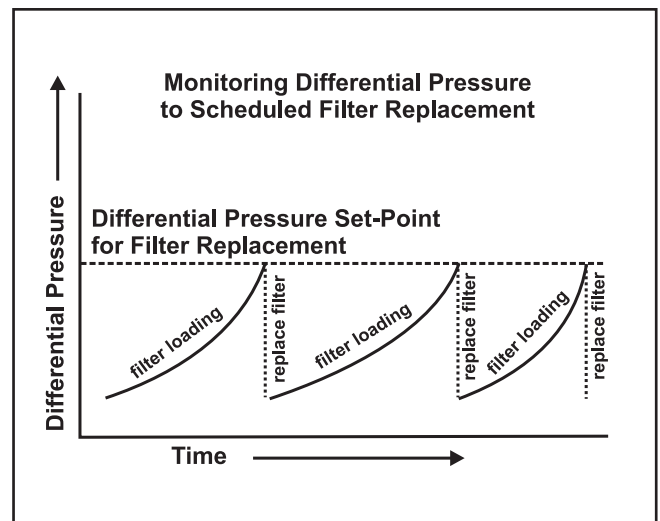
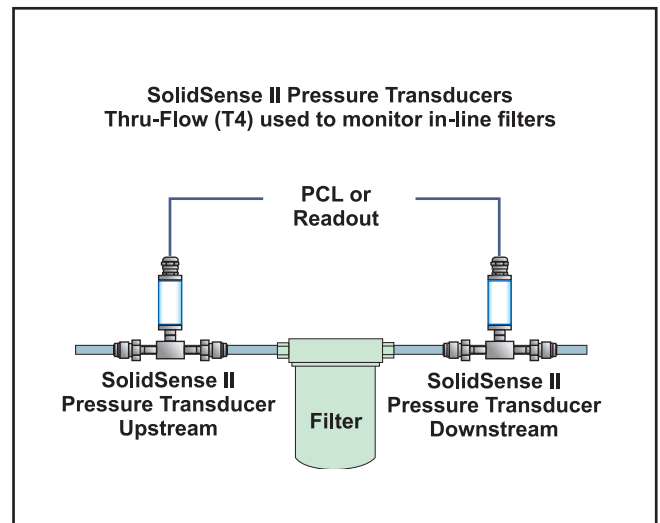
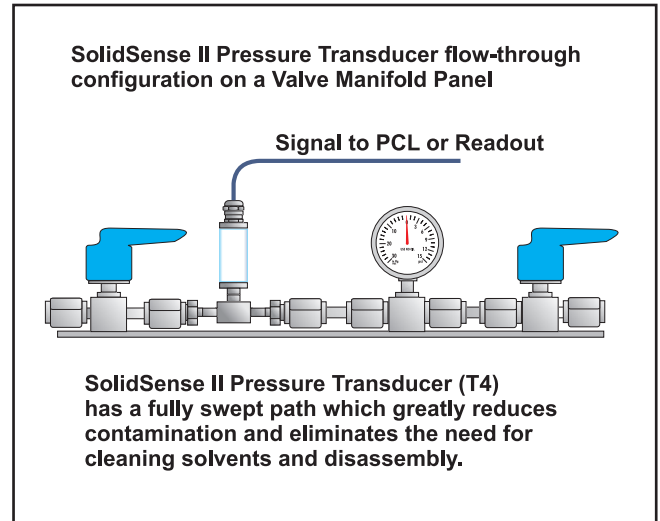

Product Specifications

Performance	Non-Display Version	Display Version
Temperature:	---	---
Operating:	-20°F to 180°F (-29°C to 82°C)	-20°F to 140°F (-29°C to 60°C)
Storage:	-40°F to 180°F (-40°C to 82°C)	-40°F to 167°F (-40°C to 75°C)
Compensated:	-4°F to 140°F (-20°C to 60°C) / 68°F to 140°F (20°C to 60°C) 0-10 Vdc version	
Burst Pressure:	400% full scale	
Design Pressure:	300% full scale up to 2000 psi, 250% full scale for higher ranges	
Proof Pressure:	200% full scale up to 2,000 psi, 150% full scale for higher ranges	
Accuracy:	0.25% full scale (BFSL)	
Response Time:	< 5 msec	
Zero and Span Temperature Coefficient (each):	---	
>100 PSI Ranges Full Scale:	+0.02% full scale/OF (-4°F to 140°F, -20°C to 60°C) +0.50% full scale (68°F to 140°F, 20°C to 60°C) 0 to 10 Vdc version	
<100 PSI Ranges Full Scale:	+0.04% full scale/OF (-4°F to 140°F, -20°C to 60°C) +1.00% full scale (68°F to 140°F, 20°C to 60°C) 0 to 10 Vdc version	
Mechanical		
Housing:	Stainless steel, polymer plastics	
Wetted Parts:	316L stainless steel, SEMI F20	
Surface Finish:	Compliant with SEMI F19	
Cleanliness:	Compliant to ASTM F1374-92 (2005)	
Internal Volume:	1.79cc	
Process Connections:	(See Product Configurations for available options)	
Approximate Shipping Weight:	0.70 lb. (0.32 kg)	
Electrical		
Supply Current:	Max. 10 mA	Max. 30 mA
Power Requirements:	10 to 30 Vdc for 4 to 20 mA output 11 to 30 Vdc for 0 to 5 Vdc output 13 to 32 Vdc for 0 to 10 Vdc output	15 to 30 Vdc for 4 to 20 mA output and no signal output 11 to 30 Vdc for 0 to 5 Vdc output 13 to 30 Vdc for 0 to 10 Vdc output
Optional Display	Non-Display Version	Display Version
Digits:	N/A	-xxx to 1xxx
Type:	N/A	7 Segment Red LED
Polarity:	N/A	Automatic (-) Display
Over Pressure Reading Trigger:	N/A	10% full scale ± 5% full scale (Display reading: 1---

Electrical (Cont.)

Display Accuracy:		$\pm 0.25\%$ of Rdg ± 1 Count for psi
(excluding transducer output)	N/A	$\pm 0.25\%$ of Rdg ± 5 Count for kPa
Character Size:	N/A	0.30" height
kPa/psi Switch:	N/A	Yes
Rotatable:	N/A	Continuous rotation covering 4 quadrants
Zero Pot:	N/A	Yes
Zero Pot Adj. Screwdriver:	N/A	1-1.2 mm flat type

Approvals and Compliance

FM Approval:	Some GFD and GFF models are FM approved. Consult factory for more information	
EMC:	Compliant to EU Directive 2004/108/EC	
RoHS	Compliant to EU Directive 2002/95/EC	

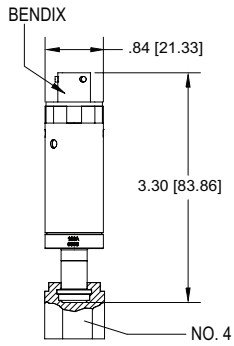

VCR SWIVEL FEMALE BENDIX

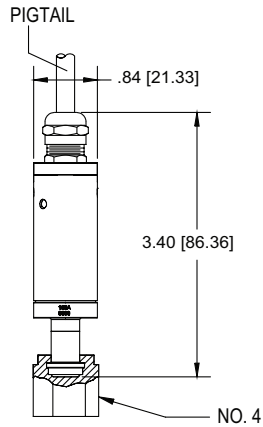

VCR SWIVEL FEMALE PIGTAIL
GFDXXXXPSF

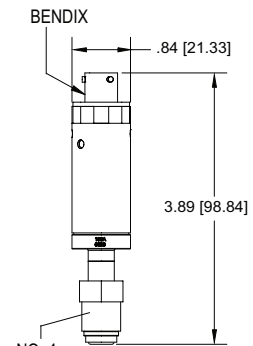

VCR SWIVEL MALE BENDIX

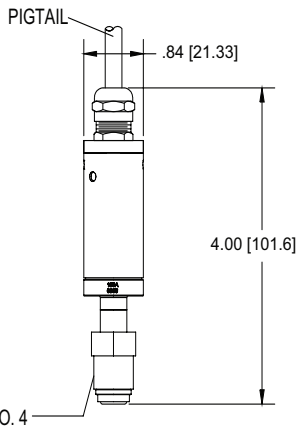

VCR SWIVEL MALE PIGTAIL
GFDXXXXPSM

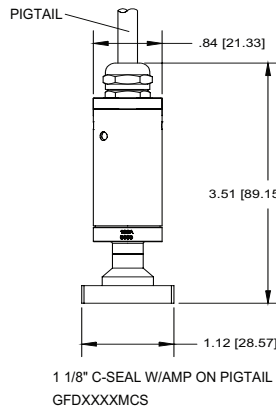

1 1/8" C-SEAL W/AMP ON PIGTAIL
GFDXXXXMCS

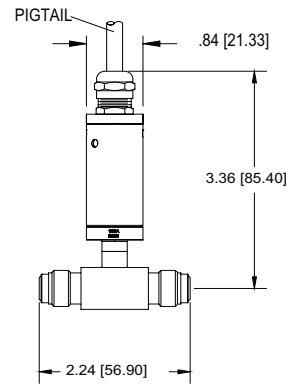

VCR FIXED MALE
THRUTUBE PIGTAIL
GFFXXXXPVM

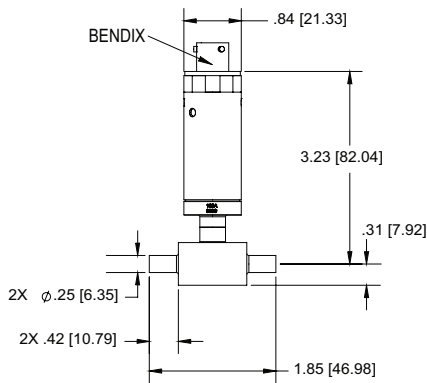

TUBE STUB/TUBE STUB
THRUTUBE BENDIX
GFFXXXXB4T

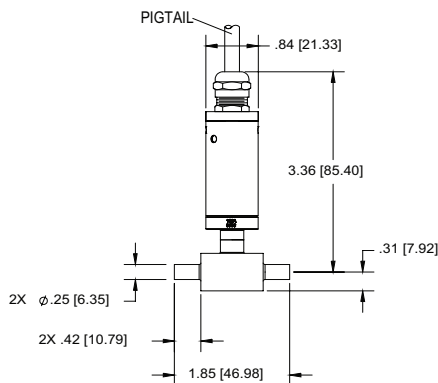

TUBE STUB/TUBE STUB
THRUTUBE PIGTAIL
GFFXXXXP4T

Shown are just a few of the most common configurations of the SolidSense II[®] pressure transducers, which are available in over 40 configurations. For more information and a complete selection of configurations available contact your Brooks Instrument sales representative.

GID/GIF Options

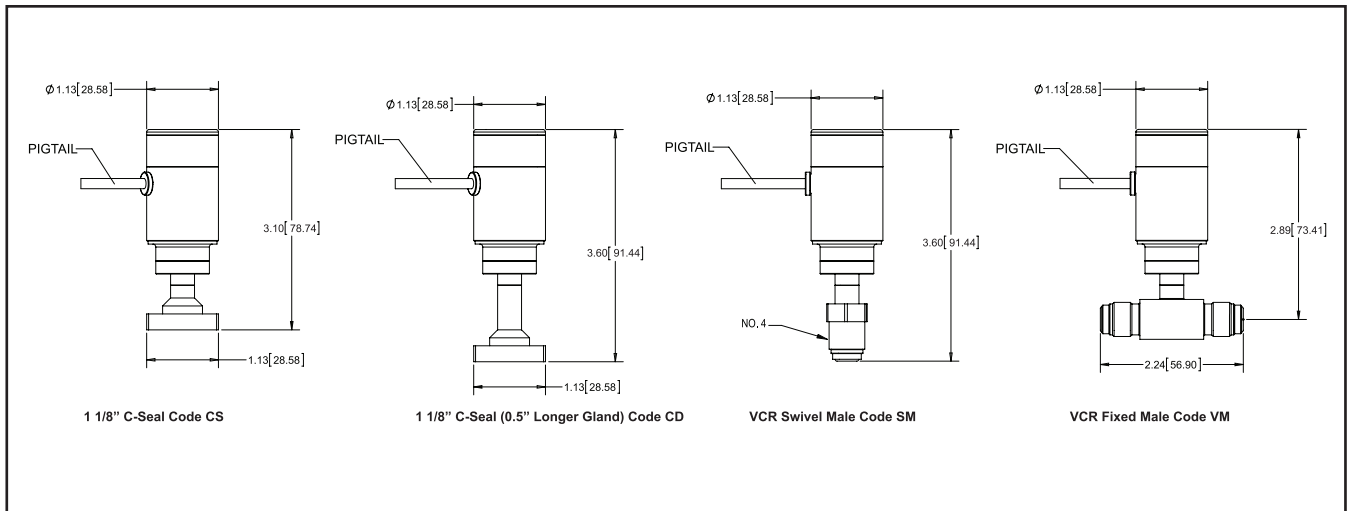

Optional Display LR056

Local display option for SolidSense II with Bendix connector and 4-20 mA output

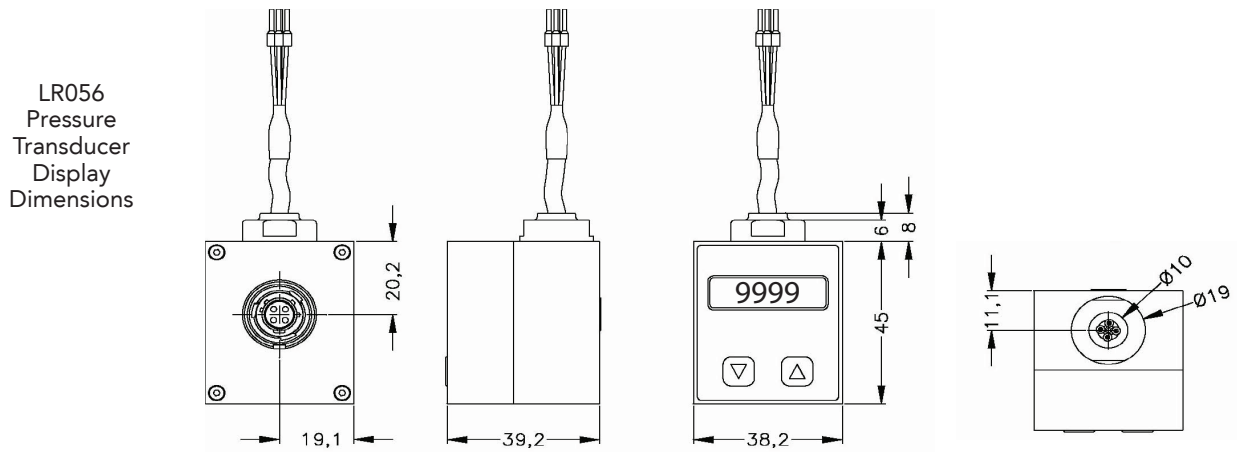

The SolidSense II pressure transducer is available with an optional display: Model LR056, for details on this display see [DS-PR-LR056-eng](#)

Code Description	Code Option	Option Description				
I. Base Model Code	GF	Pressure Transducer				
	GI	Pressure Transducer with integrated display				
II. Body Type	D	Dead End				
	F	Flow Through				
III. Pressure / Vacuum Range <i>*Refer to available combinations in Range/Unit table below</i>	00	30				
	45	45				
	60	60				
	01	100				
	02	250				
	X1	150				
	X2	235				
	05	500				
	10	1000				
	25	2500				
	30	3000				
	15	1500 Torr Only				
	IV. Pressure / Vacuum Units (Full Scale Range ¹) <i>*Refer to available combinations in Range/Unit table below</i>	A	Absolute, psi			
C		Compound, psi				
G		Gauge, psi				
B		Absolute, Bar				
P		Compound, Bar				
S		Gauge, Bar				
F		Absolute, KPa				
R		Compound, KPa/MPa				
K		Gauge, KPa				
E		Absolute, MPa				
D		Gauge, MPa				
T		Absolute Torr (available for PSI 05, 10, & 15 only)				
V. Output		3	0.00 to 10.00 Vdc			
	4	4 to 20 mA				
	5	0.05 to 5.05 Vdc				
	6	0.2 to 5.2 Vdc				
	7	2 to 10 Vdc				
	8	No signal output (GI model with display only)				
VI. Electrical Connection			GFF	GFD	GIF	GID
	A	4 ft Pigtail with AMP® Connector (3-pin) - Current Output Only			X	X
	B	Bendix® Connector	X	X		
	D	15 Pin HD D-Sub Connector - Voltage Output Only	X	X		
	E	9 inch Pigtail with 15 Pin HD D-Sub Connector - Voltage Output Only	X	X	X	X
	G	4 ft Pigtail with AMP® Connector (4-pin) - Voltage Output Only			X	X
	H	6 inch Pigtail with Molex® Connector			X	X
	K	9-pin D-Sub - Voltage Output Only	X	X		
	L	10 ft (3m) Pigtail	X	X	X	X
	M	5 inch (0.127m) Pigtail with AMP® Connector (4-pin) - Voltage Output Only			X	X
	N	16.5 ft cable with Bendix® Type (Bayonet)	X	X	X	X
	P	6 ft (2m) Pigtail	X	X	X	X
	Q	12" Pigtail with M12 Connector	X	X	X	X
	R	8 inch Pigtail with AMP® Connector (4-pin)			X	X
	S	2m (79") Pigtail with 9-Pin D Connector - Current Output Only	X	X		
	V	18 inch Pigtail with 6-pin Molex® Connector			X	X
	W	2 inch Pigtail with AMP® Connector (4-pin) plus 1" strain relief (± 1/8") at 20° angle from bottom dead center			X	X
	Y	18" Pigtail with 4 Pin AMP Connector	X		X	
	Z	36 inch Pigtail with Bendix® Connector (Bayonet)	X	X	X	X
	3	8 inch Pigtail with AMP® Connector (4-pin) - Analog Only	X	X	X	X
VII. Fittings			GFF	GFD	GIF	GID
	4S*	Tube Weld Stub 1/4" O.D.		X		
	4T*	Duncan T, 1/4" Tube Weld Stub	X			
	CD	Surface Mount, 1.125" C-Seal, 0.5" longer gland		X		X
	CH	Surface Mount, 1.5" C-Seal, High Flow K1H		X		
	CS	Surface Mount, 1.125" C-Seal, Standard		X		X
	NT	1/4" NPT		X		
	SC	Surface Mount, 1.5" C-Seal		X		
	SF	Face Seal, swivel female 1/4"	X	X	X	X
	SM	Face Seal, swivel male 1/4"	X	X	X	X
	VM	Face Seal, fixed male 1/4"	X		X	
	VS	Face Seal, fixed male/swivel female on Duncan T 1/4"	X			

Sample Standard Model Code

I	II	III	IV	V	VI	VII
GF	F	02	C	4	P	SF

*Range/Unit Available Combinations Table

III. Pressure/ Vacuum Range Code	Select Range →	00	45	60	01	X1	X2	02	05	10	14	15	25	30
IV. Pressure / Vacuum Units (Full Scale Range)	A PSI (A)	30	-	60	100	-	-	250	500	1000	-	-	2500	3000
	C PSI (C)	30	45	60	100	150	235	250	500	1000	-	1500	2500	3000
	G PSI (G)	30	-	60	100	-	-	250	500	1000	-	-	2500	3000
	B BAR (A)	2	-	-	7	-	-	17	34	69	100	-	172	207
	P BAR (C)	2	-	-	7	-	-	17	34	69	-	-	172	207
	S BAR (G)	2	-	-	7	-	-	17	34	69	-	-	172	207
	F KPa (A)	207	-	-	-	-	-	-	-	-	-	-	-	-
	R KPa (C)	207	-	-	-	-	-	-	-	-	-	-	-	-
	K KPa (G)	207	-	-	-	-	-	-	-	-	-	-	-	-
	E MPa (A)	.29	-	-	.69	-	-	1.7	3.4	6.9	-	-	17.2	20.7
	R MPa (C)	-	-	-	.69	1	-	1.7	3.4	6.9	-	-	17.2	20.7
	D MPa (G)	-	-	-	.69	-	-	1.7	3.4	6.9	-	-	17.2	20.7
	T Torr (T)	-	-	-	-	-	-	-	500	1000	-	1500	-	-

(A)=Absolute, (C)=Compound, (G)=Gauge

Brooks is committed to assuring all of our customers receive the ideal flow solution for their application, along with outstanding service and support to back it up. We operate first class repair facilities located around the world to provide rapid response and support. Each location utilizes primary standard calibration equipment to ensure accuracy and reliability for repairs and recalibration and is certified by our local Weights and Measures Authorities and traceable to the relevant International Standards.

Visit www.BrooksInstrument.com to locate the service location nearest to you.

START-UP SERVICE AND IN-SITU CALIBRATION

Brooks Instrument can provide start-up service prior to operation when required. For some process applications, where ISO-9001 Quality Certification is important, it is mandatory to verify and/or (re)calibrate the products periodically. In many cases this service can be provided under in-situ conditions, and the results will be traceable to the relevant international quality standards.

SEMINARS AND TRAINING

Brooks Instrument can provide seminars and dedicated training to engineers, end users, and maintenance persons.

Please contact your nearest sales representative for more details.

Due to Brooks Instrument's commitment to continuous improvement of our products, all specifications are subject to change without notice.

TRADEMARKS

Brooks & SolidSense II are trademarks of Brooks Instrument, LLC
All other marks are the property of their respective owners.



Data-Sheet-SolidSense II-PT-EN/2023-10

Global Headquarters

Brooks Instrument
407 West Vine Street
Hatfield, PA
19440-0903 USA

Toll-Free (USA): 888-554-FLOW
T: 215-362-3500

BrooksAM@BrooksInstrument.com

A list of all Brooks Instrument locations and contact details can be found at www.BrooksInstrument.com

©Copyright 2023 Brooks Instrument, LLC All rights reserved. Printed in U.S.A.