

GF100 Series – Analog, DeviceNet

Metal Sealed, High-Purity/Ultra-High Purity Thermal Mass Flow Controllers & Meters for Gases

Designed for semiconductor, MOCVD, and other gas flow control applications that require a high-purity all-metal flow path, the Brooks™ GF100 Series thermal mass flow controllers and meters deliver outstanding performance, reliability, and flexibility. The GF100 Series has been marathon tested to over three times the semiconductor industry standard for reliability, ensuring repeatable low-drift performance over time. An independent diagnostic/service port permits users to troubleshoot or change flow conditions without removing the mass flow controller from service.

The GF100 Series feature set was designed to enable drop-in replacement and upgrade of most brands of metal-seal mass flow controllers, including the former Celerity, UNIT, Tylan, and Mykrolis brands. With the wide range of options and features available, the GF100 Series provides users with a path to simplification and standardization, greatly reducing spares inventory and support costs.



Features

Benefits

Corrosion Resistant Hastelloy Sensor	Provides unmatched long-term sensor stability ensuring maximum yield and throughput.
Pressure Transient Insensitivity	Reduces crosstalk sensitivity for consistent mass flow delivery and reduces wafer-to-wafer variability.
Zero Leak-by Control Valve	Valve shut down (up to $\leq 0.005\%$ of F.S.) to minimize the first wafer effect, improve tool matching, and wafer-to-wafer uniformity.
GF120 Safe Delivery System (SDS [®])	Low pressure drop MFC for the delivery of sub-atmospheric safe delivery system (SDS) gases used in Implant and Etch processes.
MultiFlo™ Gas and Range Technology	Enables one MFC to support thousands of gas types and range combinations without removing it from the gas line or compromising on accuracy.

Product Specifications

	GF100	GF120	GF125	GF120XSL	GF120XSD
Performance¹					
F.S. Flow Ranges	3 sccm - 55 slm			4 sccm - 25 sccm	>25 sccm - 1 slm
Flow Accuracy	±1% S.P. >35 - 100%, ±0.35% F.S. 2 - 35%				
Repeatability & Reproducibility	5 - 100% = ±0.15% of S.P. 2 - 5% = ±0.015% of F.S.				
Linearity	±0.5% F.S. (included in accuracy)			---	
Response Time (Settling Time) N.C. Valve	<1 sec	700 ms	300 ms (3 - 860 sccm) 400 ms (861 - 7200 sccm) 500 ms (7201 - 30000 sccm) < 700 ms (30001 - 55000 sccm)	< 3 sec	
N.O. Valve	<1.5 sec			---	
Pressure Insensitivity	Not Applicable		<5% S.P. up to 5 psi/sec upstream pressure spike	Not Applicable	
Control Range	2 - 100% (Normally Closed Valve) 3 - 100% (Normally Open Valve)			2 - 100% (Normally Closed Valve)	
MultiFlo™	Standard			---	
# of Bins	11 bins			---	
Valve Shut Down (N.C. Valve) ^{2,3}	Standard Hastelloy Valve: <1% of F.S. Zero Leak-by Valve: SH40 - SH41 <0.02% F.S. SH42 - SH50 <0.005% F.S.			Standard Hastelloy Valve: <1% of F.S.	
Valve Shut Down (N.O. Valve)	2% of F.S.			---	
Zero Stability	<±0.5% F.S. per year			<±0.6% F.S. per year	
Temperature Coefficient	Zero: 0.005% F.S. per °C; Span: 0.05% F.S. per °C				

Ratings

Operating Temperature Range	10 - 50°C				
Differential Pressure Range ⁴	3 - 860 sccm = 7 - 45 psid 861 - 7200 sccm = 10 - 45 psid 7201 - 55000 sccm = 15 - 45 psid			10 Torr - 30 psid typical For more details consult factory	
Maximum Operating Pressure	500 psia max		100 psia max		500 psia max
Proof Pressure	700 psia max		140 psia max		700 psia max
Design Pressure	800 psia max		170 psia max		800 psia max
Burst Pressure	3000 psia max		500 psia max		3000 psia max
Leak Integrity (External)	1x10 ⁻¹⁰ atm. cc/sec He				

Mechanical

Valve Type	Normally Closed (Standard or Zero Leak-by) Normally Open Meter (no valve)			Normally Closed	
Wetted Materials	SEMI F20 HP Compliant, 316L VIM/VAR, Hastelloy C-22, 316L Stainless Steel, 304 Stainless Steel, KM-45, PCTFE (on optional Zero Leak-by Valve)				
Surface Finish	10μ inch Ra				5μ inch Ra

Display & Diagnostics

Status Lights	MFC Health, Network Status				
Alarms	Control Valve Output, Network Interruption				
Display Type	Top Mount Integrated LCD				
Viewing Angle / Viewing Distance	Fixed / 10 feet				
Units Displayed / Resolution	Flow (%), Temp. (°C), Pressure (psia, kPa) / 0.1 (unit)				

NOTE: Consult Brooks Applications Engineering for accuracy and response for analog communications.

NOTE: See the following Safe Delivery System (SDS) section for optional detailed specifications.

¹ Based on factory N₂ calibration.

² The Zero Leak-by Valve can be ordered via the Customer Special Request process.

³ Valve Shut Down full scale is defined as the MultiFlo™ full scale bin range or the full scale range of the factory configured gas & range devices.

⁴ Argon gas applications require an additional 10 psid differential pressure. Devices greater than 30L require a 45 psia minimum inlet pressure. Low vapor pressure gases require an inlet pressure of > 100 Torr, with vacuum on outlet (example SiCl₄). Contact Brooks Technical Support for more information.

Product Specifications

	GF100	GF120	GF125	GF120XSL	GF120XSD
--	-------	-------	-------	----------	----------

Electrical

Electrical Connection	RS485 / Analog via 9-Pin "D" connector, DeviceNet™ via 5-Pin "M12" connector				
Digital Communication	RS485+ (model specific), DeviceNet (model specific), RS485 Diagnostic Port (all models)				
Diagnostics / Service Port	RS485 via 2.5mm jack				
Power Supply / Consumption	DeviceNet: 545 mA max. @ +11 - 25 Vdc., 250 mA max. @ 24 Vdc RS485 / Analog: 6 Watts max @ ±15 Vdc. (±10%) or + 24 Vdc (±10%)				

Compliance

EMC	EC Directive 2004/108/EC CE: EN61326: 2006 (FCC Part 15 & Canada IC-subset of CE testing) RoHS Directive (2011/65/EU) REACH Directive EC 1907/2006				
Environmental Compliance					

Product Specifications

	GF101	GF121	GF126
Performance¹			
F.S. Flow Range	55 slm - 300 slm		
Flow Accuracy	±1% S.P. >35 - 100%; ±0.35% F.S. 2 - 35%		
Repeatability & Reproducibility	<±0.15% S.P.		
Response Time (Setting Time) N.C. Valve	<1 sec		
Pressure Insensitivity	Not Applicable	Ability to measure inlet pressure	
Control Range	5 - 100% (N.C. Valve)		
MultiFlo™	Standard		
# of Bins	4 bins		
Valve Shut Down (N.C. Valve) ²	<2% of F.S. @ 30 N ₂ psig/atm out		
Zero Stability	<±0.5% F.S. per year		
Temperature Coefficient	Zero: 0.005% F.S. per °C; Span: 0.05% F.S. per °C		

Ratings			
Operating Temperature Range	10 - 50°C		
Differential Pressure Range	30 - 90 psid		
Maximum Operating Pressure	Controller: 75 psig Meter: 150 psig		
Proof Pressure	700 psia	140 psia	
Design Pressure	800 psia	700 psia	170 psia
Burst Pressure	3000 psia		500 psia
Leak Integrity (External)	1x10 ⁻¹⁰ atm. cc/sec He		

Mechanical			
Valve Type	Normally Closed Meter (no valve)		
Wetted Materials	SEMI F20 HP Compliant, 316L VIM/VAR, Hastelloy C-22, 316L Stainless Steel, 304 Stainless Steel, KM-45		
Surface Finish	10µ inch Ra	5µ inch Ra	

Diagnostics & Display			
Status Lights	MFC Health, Network Status		
Alarms	Control Valve Output, Network Interruption		
Display Type	Top Mount Integrated LCD		
Viewing Angle / Viewing Distance	Fixed / 10 feet		
Units Displayed / Resolution	Flow (%), Temp. (°C), Pressure (psia, kPa) / 0.1 (unit)		

Electrical			
Electrical Connection	RS485 / Analog via 9-Pin "D" connector, DeviceNet™ via 5-Pin "M12" connector		
Digital Communication	RS485+ (model specific), DeviceNet (model specific), RS485 Diagnostic Port (all models)		
Diagnostic / Service Port	RS485 via 2.5mm jack		
Power Supply / Consumption	DeviceNet: 545 mA max. @ +11-25 Vdc., 250 mA max. @ 24 Vdc (Under typical operating conditions) RS485 / Analog: 6 Watts max @ +15 Vdc. (+10%) (Under typical operating conditions)		

Compliance			
EMC	EC Directive 2004/108/EC CE: EN61326: 2006 (FCC Part 15 & Canada IC-subset of CE testing)		
Environmental Compliance	RoHS Directive (2011/65/EU) Reach Directive EC (1907/2006)		

¹ Based on factory N₂ calibration.

² Valve Shut Down full scale is defined as the MultiFlo™ full scale bin range or the full scale flow range of the factory configured gas & range devices.

GF100 / GF120 / GF125 Downport Configurations

Electrical Connector
DX / BB Specific Dimensions

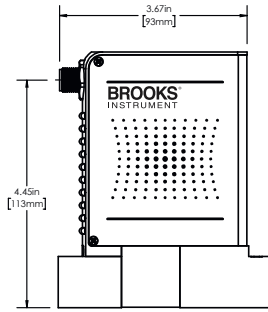

Electrical Connector
G1 / GX / TX Specific Dimensions

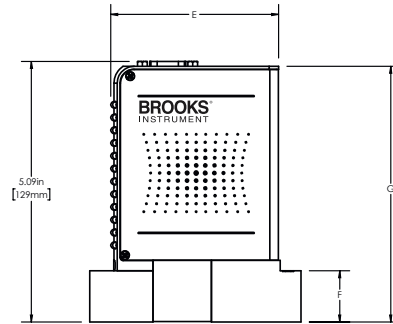

Electrical Connector
SX Specific Dimensions

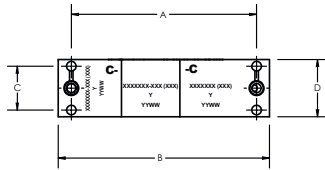
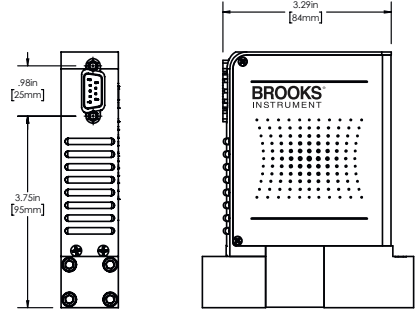

Fitting Option Code	Seal Type	Dim A	Dim B	Dim C	Dim D	Dim E	Dim F	Dim G
CX	C-SEAL	3.62in [92mm]	4.13in [105mm]	0.86in [22mm]	1.12in [28mm]	3.28in [83mm]	1.00in [25mm]	5.00in [127mm]
EX	W-SEAL	3.14in [79.8mm]	3.66in [93mm]	1.18in [1.18mm]	1.48in [38mm]	2.82in [72mm]	1.00in [25mm]	5.00in [127mm]
WX	W-SEAL	3.62in [92mm]	4.13in [105mm]	0.86in [22mm]	1.12in [28mm]	3.28in [83mm]	1.00in [25mm]	5.00in [127mm]
DX	C-SEAL	3.14in [79.8mm]	3.66in [93mm]	0.86in [22mm]	1.12in [28mm]	2.82in [72mm]	1.00in [25mm]	5.00in [127mm]
YX	W-SEAL	3.14in [79.8mm]	3.66in [93mm]	0.86in [22mm]	1.12in [28mm]	2.82in [72mm]	1.00in [25mm]	5.00in [127mm]
AX	C-SEAL	3.62in [92mm]	4.13in [105mm]	1.18in [30mm]	1.48in [38mm]	3.28in [83mm]	1.00in [25mm]	5.00in [127mm]
BX	W-SEAL	3.62in [92mm]	4.13in [105mm]	1.18in [30mm]	1.48in [38mm]	3.28in [83mm]	1.00in [25mm]	5.00in [127mm]
LX	C-SEAL	3.62in [92mm]	4.13in [105mm]	0.86in [22mm]	1.12in [28mm]	3.28in [83mm]	1.00in [25mm]	5.00in [127mm]
AS	Large Bore C-SEAL	3.62in [92mm]	4.13in [105mm]	1.18in [30mm]	1.48in [38mm]	3.28in [83mm]	1.00in [25mm]	5.00in [127mm]

GF100 / GF120 / GF125 Face Seal Configurations

Electrical Connector
DX / BB Specific Dimensions

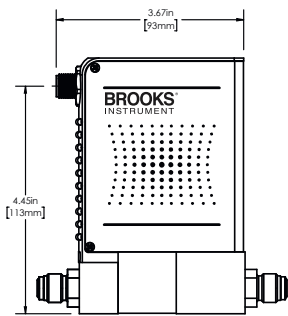

Electrical Connector
G1 / GX / TX Specific Dimensions

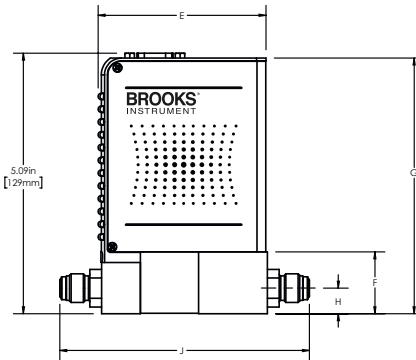

Electrical Connector
SX Specific Dimensions

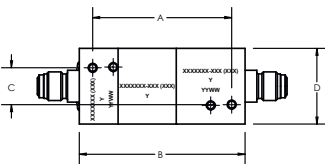
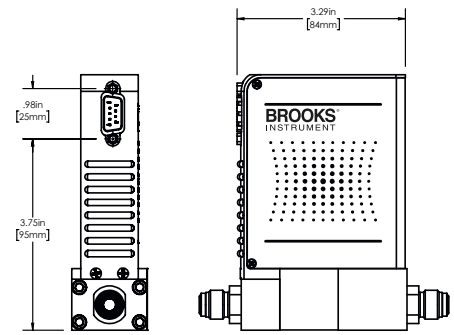

Fitting Option Code	Seal Type	Dim A	Dim B	Dim C	Dim D	Dim E	Dim F	Dim G	Dim H	Dim J
VX	1/4" VCR	2.72in [69mm]	3.24in [82mm]	0.72in [18mm]	1.48in [38mm]	3.28in [83mm]	1.21in [31mm]	5.0in [127mm]	0.50in [13mm]	4.88in [124mm]
VS	1/4" VCR	2.72in [69mm]	3.24in [82mm]	0.72in [18mm]	1.12in [28.4mm]	3.28in [83mm]	1.21in [31mm]	5.0in [127mm]	0.50in [13mm]	4.88in [124mm]

GF101 / GF121 / GF126 Downport Configurations

Electrical Connector
DX Specific Dimensions

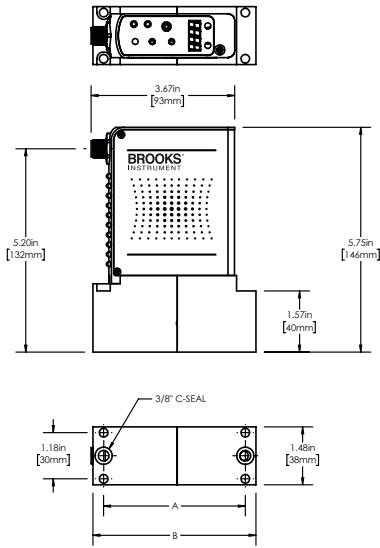

Electrical Connector
G1 / GX Specific Dimensions

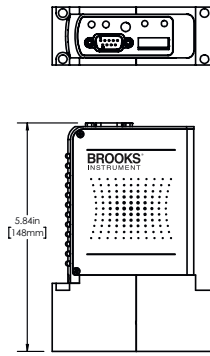

Electrical Connector
SX Specific Dimensions

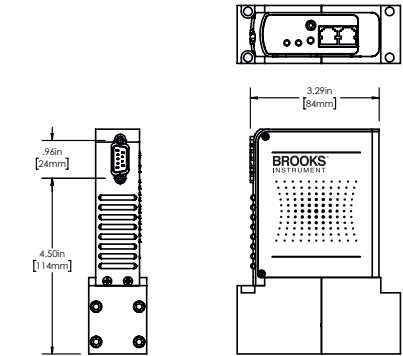

Fitting Option Code	Seal Type	Dim A	Dim B
C1	3/8" C-Seal	3.62in [92mm]	4.17in [106mm]
C2	3/8" C-Seal	4.49in [114mm]	5.00in [127mm]

GF101 / GF121 / GF126 Face Seal Configurations

Electrical Connector
DX Specific Dimensions

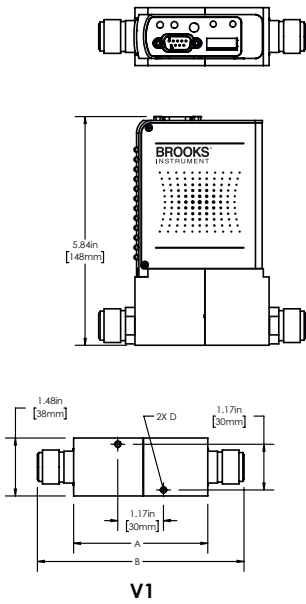

Electrical Connector
G1 / GX Specific Dimensions

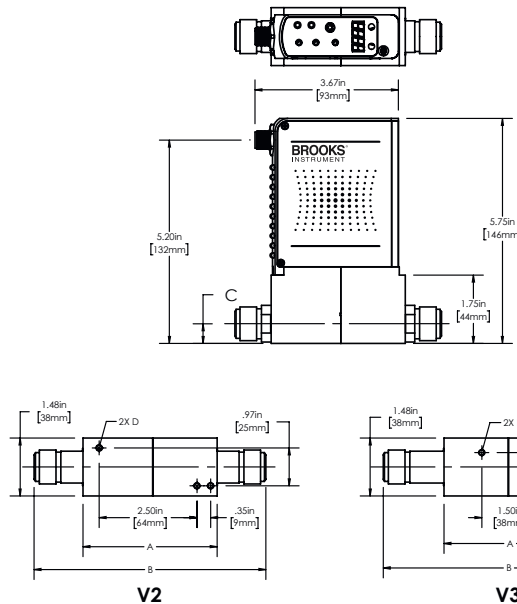

Electrical Connector
SX Specific Dimensions

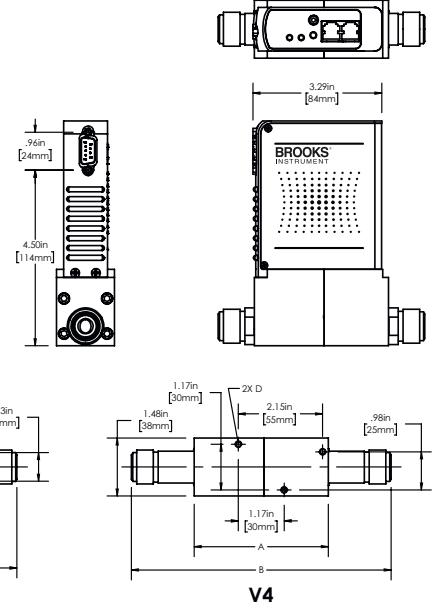

Fitting Option Code	Seal Type	Dim A	Dim B	Dim C	Dim D
V1	1/2" VCR	3.43in [87mm]	5.28in [134.2mm]	0.50in [12.7mm]	M4 X 0.7 X 0.23in [5.8mm] DEEP
V2	1/2" VCR	3.43in [87mm]	5.92in [150.4mm]	0.62in [15.5mm]	M4 X 0.7 X 0.23in [5.8mm] DEEP
V3	1/2" VCR	3.43in [87mm]	6.54in [166mm]	0.49in [12.4mm]	M4 X 0.7 X 0.23in [5.8mm] DEEP
V4	1/2" VCR	3.43in [87mm]	6.64in [168.6mm]	0.63in [16.0mm]	M4 X 0.7 X 0.23in [5.8mm] DEEP

Product Connections

Base I/O Options

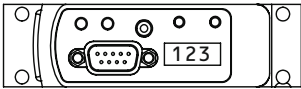

Description: Industry standard Analog / RS485 interface

Model Code Option: G1

Pin	Description	
1	Valve Control	
2	Output (0 - 5 Vdc)	
3	+15 Vdc	+24 Vdc
4	Pwr Com	NC
5	-15 Vdc	Pwr Com
6	Setpoint (0 - 5 Vdc)	
7	Signal Common	
8	RS485 (DX+)	
9	RS485 (DX-)	

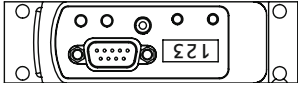

Description: OEM specific Analog / RS485 interface. Display and top plate re-oriented 180°

Model Code Option: GX

Pin	Description	
1	Valve Control	
2	Output (0 - 5 Vdc)	
3	+15 Vdc	+24 Vdc
4	Pwr Com	NC
5	-15 Vdc	Pwr Com
6	Setpoint (0 - 5 Vdc)	
7	Signal Common	
8	RS485 (DX+)	
9	RS485 (DX-)	

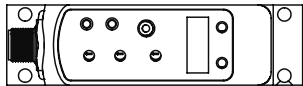

Description: Industry standard ODVA compliant DeviceNet interface

Model Code Option: DX

Pin	Description
1	Drain
2	V+ (11 - 25 Vdc)
3	V-
4	CAN-H
5	CAN-L

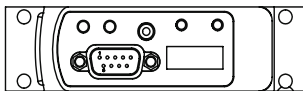

Description: Industry standard Analog only interface

Model Code Option: TX

Pin	Description	
1	Valve Control	
2	Output (0 - 5 Vdc)	
3	+15 Vdc	+24 Vdc
4	Pwr Com	NC
5	-15 Vdc	Pwr Com
6	Setpoint (0 - 5 Vdc)	
7	Signal Common	
8	No Connection	
9	No Connection	

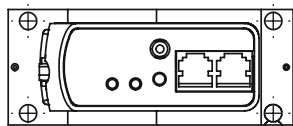

Description: Industry standard Analog 9-Pin Sub D connector and dual RJ11 RS485 ports

Model Code Option: SX

Pin	Description	
1	Valve Control	
2	Output (0 - 5 Vdc)	
3	+15 Vdc	+24 Vdc
4	Pwr Com	NC
5	-15 Vdc	Pwr Com
6	Setpoint (0 - 5 Vdc)	
7	Signal Common	
8	Signal Common	
9	Valve Test Point	
RJ11 Pin	Description	
3	RS485 (DX-)	
4	RS485 (DX+)	

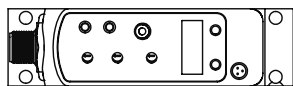

Description: Industry standard ODVA compliant DeviceNet interface, Plus a separate Analog 0-5 Vdc Connector

Model Code Option: BB

Pin	Description
1	Drain
2	V+ (11 - 25 Vdc)
3	V-
4	CAN-H
5	CAN-L
HIROSE Pin	Description
1	Flow Out
2	AGND
3	GPIO CAP0
4	GHD Earth

All Base I/O options include:
Diagnostic port communication RS485 via 2.5mm jack

Adapter Cables with Base I/O Option

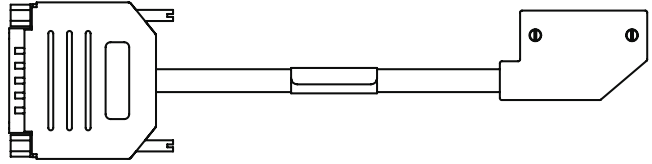

A range of low profile adapter cables have been developed to support replacing older generation MFCs with different pinout configurations. The base MFC will be either a G1, TX or SX configuration, depending on the product being replaced.

Model Code Option: UX

Pin	Description	
9	Valve Off	
6	Output (0 - 5 Vdc)	
4	+15 Vdc	+24 Vdc
7	Pwr Com	NC
11	-15 Vdc	Pwr Com
15	Setpoint (0 - 5 Vdc)	
1,13,14	Signal Common	
2	Zero Alarm	
12	Valve Test Point	
8	Case Ground	
3,5,10	No Connection	

Description: SX base I/O with 7003550 adapter for compatibility with Unit UDU15

Model Code Option: EX

Pin	Description	
J	Valve Off	
3	Output (0 - 5 Vdc)	
4	+15 Vdc	+24 Vdc
2	Pwr Com	NC
F	-15 Vdc	Pwr Com
A	Setpoint (0 - 5 Vdc)	
B,C,10	Signal Common	
1	Case Ground	
5,6,8,9	Not Connected	
I,D,E,H	Not Connected	
7,G	Key Way	
J2	J3	
3	3	RS485 (DX-)
4	4	RS485 (DX+)

Description: GX base I/O with 7003083 adapter

Model Code Option: FX/JX

Pin	Description	
1	Valve Control*	
2	Output (0 - 5 Vdc)	
3	+15 Vdc	+24 Vdc
4	Pwr Com	NC
5	-15 Vdc	Pwr Com
6	Setpoint (0 - 5 Vdc)	
7	Signal Common	
8	Signal Common	
9	Valve Test Point	

Description: SX base I/O with 7003069 (FX) / 7001814 (JX) adapter for compatibility with Unit UDF9 / UDJ9

Model Code Option: BX

Pin	Description	
12	Valve Override	
2	Output (0 - 5 Vdc)	
5	+15 Vdc	+24 Vdc
9	Pwr Com	NC
6	-15 Vdc	Pwr Com
8	Setpoint (0 - 5 Vdc)	
1,10	Signal Common	
3,4,7,11	No Connection	
13,14,15	No Connection	

Description: G1 base I/O with 7003590 adapter for compatibility with Brooks 15-Pin D

Model Code Option: KX

Pin	Description	
3	Valve Control	
2	Output (0 - 5 Vdc)	
7	+15 Vdc	+24 Vdc
5	Pwr Com	NC
6	-15 Vdc	Pwr Com
8	Setpoint (0 - 5 Vdc)	
11,12	Signal Common	
15	Case Ground	
1,4,9,10,13,14	No Connection	

Description: G1 base I/O with 7003298 adapter for compatibility with Unit UDK15

Other adapter options are available for the GF Series.
Please contact Brooks Customer Service for more information.

Model Code - Standard Flow Range

Code Description	Code Option	Option Description
I. Base Model Code	GF	High-Purity / Ultra-High Purity Digital Mass Flow Controllers
II. Package / Finish Specifications	100	Flow range 3 sccm - 55 slpm N ₂ Eq.; 1 sec Response; 10 Ra
	120	Flow range 3 sccm - 55 slpm N ₂ Eq.; 700 msec Response; 5 Ra
	125	Pressure Transient Insensitive (PTI) Flow range 3 sccm - 55 slpm N ₂ Eq.; ± 1.0% S.P. Accuracy; 300 - 700 msec Response; 5 Ra
III. Configurability	C	MultiFlo™ capable. Standard bins or specific gas / range may be selected.
	X	Not MultiFlo™ capable. Specific gas / range required (must select with SD, SL or HA special application).
IV. Special Application	XX	Standard
	SL	Safe Delivery System (GF120 Only) F.S. flow range; 4 - 25 sccm, N ₂ Eq.
	SD	Safe Delivery System (GF120 Only) F.S. flow range; > 25 sccm - 1 slpm, N ₂ Eq.
V. Valve Configuration	O	Normally Open Valve (not available with SD, SL or HA options)
	C	Normally Closed Valve (must select with SD, SL or HA special application)
	M	Meter (No Valve)
VI. Gas or SH MultiFlo™ Bin	XXXX XXXX	Specific Gas Code & Range, i.e. "0004" = Argon and "100L" = 100 slpm (must select with SD, SL or HA special application)
	SH40 010C	Standard Configuration #40, 3 - 10 sccm N ₂ Eq. (0°C Reference)
	SH41 030C	Standard Configuration #41, 11 - 30 sccm N ₂ Eq. (0°C Reference)
	SH42 092C	Standard Configuration #42, 31 - 92 sccm N ₂ Eq. (0°C Reference)
	SH43 280C	Standard Configuration #43, 93 - 280 sccm N ₂ Eq. (0°C Reference)
	SH44 860C	Standard Configuration #44, 281 - 860 sccm N ₂ Eq. (0°C Reference)
	SH45 2.6L	Standard Configuration #45, 861 - 2600 sccm N ₂ Eq. (0°C Reference)
	SH46 7.2L	Standard Configuration #46, 2601 - 7200 sccm N ₂ Eq. (0°C Reference)
	SH47 015L	Standard Configuration #47, 7201 - 15000 sccm N ₂ Eq. (0°C Reference)
	SH48 030L	Standard Configuration #48, 15001 - 30000 sccm N ₂ Eq. (0°C Reference)
	SH49 040L	Standard Configuration #49, 30001 - 40000 sccm N ₂ Eq. (0°C Reference)
SH50 055L	Standard Configuration #50, 40001 - 55000 sccm N ₂ Eq. (0°C Reference)	
VII. Fitting	VX	1-1/2" body width, 124mm 1/4" VCR male
	VS	1-1/8" body width, 124mm 1/4" VCR male
	CX	1-1/8" body width, 92mm C Seal
	DX	1-1/8" body width, 79.8mm C Seal
	EX	1-1/2" body width, 79.8mm W Seal
	WX	1-1/8" body width, 92mm W Seal
	YX	1-1/8" body width, 79.8mm W Seal
	AX	1-1/2" body width, 92mm C Seal
	BX	1-1/2" body width, 92mm W Seal
	LX	1-1/8" body width, 92mm C Seal with Poke Yoke
	AS	1-1/2" body width, 92mm 0.440" large bore C Seal (only for bins SH45-SH50)
VIII. Downstream	A	Atmosphere
	V	Vacuum; Default for SD, SL and HA special application
IX. Sensor	O	Default Sensor Orientation

Code Description	Code Option	Option Description										
X. Communications / Connector	BX	Cable adapter to 15-pin D Brooks; adapts G1 base										
	EX	Cable adapter to card edge (without VTP), RS485 through RJ11 jacks; adapts GX base (Not Available on 79.8mm fitting DX, YX, EX)										
	FX	Cable adapter with 9-pin STEC pin-out & jack screws (with VTP); adapts SX base										
	GX	9-Pin D with RS485 (Not Available on 79.8mm fitting DX, YX, EX)										
	G1	9-Pin D with RS485										
	JX	Cable adapter with 9-pin STEC pin-out & jack screws (with VTP); adapts SX base										
	KX	Cable adapter to MKS 15-Pin D; adapts G1 base										
	SX	9-pin D with STEC pin-out (with VTP)										
	TX	9-pin D with UDT9 pin-out (UDT9) (Not Available on 79.8mm fitting DX, YX, EX)										
	UX	Cable adapter to 15-pin D (with VTP); adapts SX base										
	BB	DeviceNet™ Analog (Not Available on 79.8mm fitting DX, YX, EX)										
	DeviceNet Standard Configuration Parameters											
		Code Option	I/O	Connector	Power On State	Full Scale Setting	Full Scale Setting	Full Scale Setting	Poll I/O Instance Producer	Poll I/O Instance Consumer	Poll I/O State Transition	External Baud Rate
	D0	DeviceNet	5-Pin Micro	Idle	Count	Integer	6000h	2	7	Executing	500KB	
	D1	DeviceNet	5-Pin Micro	Idle	Count	Integer	6000h	21	7	Executing	500KB	
	D2	DeviceNet	5-Pin Micro	Idle	SCCM	Float	7FFFh	13	19	Executing	500KB	
	D3	DeviceNet	5-Pin Micro	Idle	Count	Integer	6000h	22	7	Executing	500KB	
	D4	DeviceNet	5-Pin Micro	Executing	Count	Integer	6000h	22	8	Executing	500KB	
	D5	DeviceNet	5-Pin Micro	Idle	Count	Integer	6000h	6	8	Executing	500KB	
	D6	DeviceNet	5-Pin Micro	Idle	Count	Integer	7FFFh	3	7	Executing	500KB	
	D7	DeviceNet	5-Pin Micro	Idle	Count	Integer	7FFFh	6	8	Executing	500KB	
	D8	DeviceNet	5-Pin Micro	Idle	Count	Integer	6000h	3	7	Executing	500KB	
	D9	DeviceNet	5-Pin Micro	Executing	Count	Integer	6000h	2	7	Executing	500KB	
	DA	DeviceNet	5-Pin Micro	Idle	Count	Integer	7FFFh	22	7	Executing	500KB	
	DB	DeviceNet	5-Pin Micro	Idle	Count	Integer	6000h	22	8	Executing	500KB	
	DC	DeviceNet	5-Pin Micro	Idle	Count	Integer	7FFFh	3	7	Idle	500KB	
	DD	DeviceNet	5-Pin Micro	Executing	Count	Integer	7FFFh	22	8	Executing	500KB	
	DE	DeviceNet	5-Pin Micro	Executing	SCCM	Float	6000h	15	19	Executing	500KB	
	DX	DeviceNet	5-Pin Micro	To be defined by Customer Special Request								
XI. Customer Special Request	XXXX	Customer Special Request Number; required with "DX, BB" Conn. Option to define DNet settings										
XII. Auto Shut-Off	A	Auto Shut-Off (Included) Default for SD and SL special application										
	X	Auto Shut-Off (Not Included) (Must be selected for meter)										
XIII. Auto Zero	X	Auto Zero (Not Included)										
XIV. Reference Temperature	000	0°C Reference Calibration (Standard) - Default Setting										

Sample Standard Model Code

I	II	III	IV	V	VI	VII	VIII	IX	X	XI	XII	XIII	XIV				
GF	100	C	XX	M	-	SH40 010C	-	VX	A	O	GX	-	XXXX	A	X	-	000

Sample Safe Delivery System (SDS) Model Code

I	II	III	IV	V	VI	VII	VIII	IX	X	XI	XII	XIII	XIV				
GF	120	X	SD	C	-	XXXX XXXX	-	EX	V	O	SX	-	XXXX	A	X	-	000

Model Code - High Flow Range

Code Description	Code Option	Option Description
I. Base Model Code	GF	High-Purity / Ultra-High Purity Digital Mass Flow Controllers
II. Package / Finish Specifications	101	Flow range 55 - 300 slm N ₂ Eq.; 10 Ra HP wetted flow path
	121	Flow range 55 - 300 slm N ₂ Eq.; 5 Ra UHP wetted flow path
	126	Flow range 55 - 300 slm N ₂ Eq.; 5 Ra UHP wetted flow path & integrated pressure measurement
III. Configurability	C	MultiFlo™ capable
	X	Not configurable
IV. Special Application	XX	Standard
V. Valve Configuration	C	Normally Closed Valve
	M	Meter (No Valve)
VI. Gas or SH MultiFlo™ Bin	XXXX XXXX	Specific Gas Code & Range, i.e. "0004" = Argon and "100L" = 100 slpm
	SH51 055L	Standard Configuration #51, 55,001 sccm N ₂ Equivalent (0 °C Reference) Special Bin for low density gases, e.g. 73,002 - 120,000 He, 100,002 - 170,000 H ₂
	SH52 100L	Standard Configuration #52, 55,002 - 100,000 sccm N ₂ Equivalent (0°C Reference)
	SH53 200L	Standard Configuration #53, 100,001 - 200,000 sccm N ₂ Equivalent (0°C Reference)
	SH54 300L	Standard Configuration #54, 200,001 - 300,000 sccm N ₂ Equivalent (0°C Reference)
VII. Fitting	V1	1 - 1/2" body width, 134mm 1/2" VCR male
	V2	1 - 1/2" body width, 150.4mm 1/2" VCR male
	V3	1 - 1/2" body width, 166mm 1/2" VCR male
	V4	1 - 1/2" body width, 168.6mm 1/2" VCR male
	Order V1 + 318Z138BNA	1 - 1/2" body width, 192.4mm 1/2" VCR male
	C1	1 - 1/2" body width, 92mm 3/8" C Seal
	C2	1 - 1/2" body width, 114mm 3/8" C Seal
VIII. Downstream	A	Atmosphere
	V	Vacuum
IX. Sensor	O	Default Sensor Orientation

Code Description	Code Option	Option Description									
X. Communications / Connector	BX	Cable adapter to 15-pin D Brooks; adapts G1 base									
	EX	Cable adapter to card edge (without VTP), RS485 through RJ11 jacks; adapts G1 base									
	FX	Cable adapter with 9-pin STEC pin-out & jack screws (with VTP); adapts SX base									
	G1	9-Pin D with RS485									
	GX	9-Pin D with RS485 (Not Available on 79.8mm fitting DX, YX, EX)									
	JX	Cable adapter with 9-pin STEC pin-out & jack screws (with VTP); adapts SX base									
	KX	Cable adapter to MKS 15-Pin D; adapts G1 base									
	SX	9-pin D with STEC pin-out (with VTP)									
	UX	Cable adapter to 15-pin D (with VTP); adapts SX base									
	DeviceNet Standard Configuration Parameters										
	Code Option	I/O	Connector	Power On State	Full Scale Setting	Full Scale Setting	Full Scale Setting	Poll I/O Instance Producer	Poll I/O Instance Consumer	Poll I/O State Transition	External Baud Rate
	D0	DeviceNet	5-Pin Micro	Idle	Count	Integer	6000h	2	7	Executing	500KB
	D1	DeviceNet	5-Pin Micro	Idle	Count	Integer	6000h	21	7	Executing	500KB
	D2	DeviceNet	5-Pin Micro	Idle	SCCM	Float	7FFFh	13	19	Executing	500KB
	D3	DeviceNet	5-Pin Micro	Idle	Count	Integer	6000h	22	7	Executing	500KB
	D4	DeviceNet	5-Pin Micro	Executing	Count	Integer	6000h	22	8	Executing	500KB
	D5	DeviceNet	5-Pin Micro	Idle	Count	Integer	6000h	6	8	Executing	500KB
	D6	DeviceNet	5-Pin Micro	Idle	Count	Integer	7FFFh	3	7	Executing	500KB
	D7	DeviceNet	5-Pin Micro	Idle	Count	Integer	7FFFh	6	8	Executing	500KB
	D8	DeviceNet	5-Pin Micro	Idle	Count	Integer	6000h	3	7	Executing	500KB
	D9	DeviceNet	5-Pin Micro	Executing	Count	Integer	6000h	2	7	Executing	500KB
	DA	DeviceNet	5-Pin Micro	Idle	Count	Integer	7FFFh	22	7	Executing	500KB
	DB	DeviceNet	5-Pin Micro	Idle	Count	Integer	6000h	22	8	Executing	500KB
	DC	DeviceNet	5-Pin Micro	Idle	Count	Integer	7FFFh	3	7	Idle	500KB
	DD	DeviceNet	5-Pin Micro	Executing	Count	Integer	7FFFh	22	8	Executing	500KB
	DE	DeviceNet	5-Pin Micro	Executing	SCCM	Float	6000h	15	19	Executing	500KB
	DX	DeviceNet	5-Pin Micro	To be defined by Customer Special Request							
XI. Customer Special Request	XXXX	Customer Special Request Number									
XII. Auto Shut-Off	A	Auto Shut-Off (Included)									
	X	Auto Shut-Off (Not Included) (Must be selected for meter)									
XIII. Auto Zero	A	Auto Zero (Included)									
	X	Auto Zero (Not Included)									
XIV. Reference Temperature	000	0°C Reference Calibration (Standard) - Default Setting									

Sample High Flow Range Model Code

I	II	III	IV	V	VI	VII	VIII	IX	X	XI	XII	XIII	XIV				
GF	101	C	XX	C	-	SH52 100L	-	V1	A	O	G1	-	XXXX	A	X	-	000

Brooks is committed to assuring all of our customers receive the ideal flow solution for their application, along with outstanding service and support to back it up. We operate first class repair facilities located around the world to provide rapid response and support. Each location utilizes primary standard calibration equipment to ensure accuracy and reliability for repairs and recalibration and is certified by our local Weights and Measures Authorities and traceable to the relevant International Standards.

Visit www.BrooksInstrument.com to locate the service location nearest to you.

START-UP SERVICE AND IN-SITU CALIBRATION

Brooks Instrument can provide start-up service prior to operation when required. For some process applications, where ISO-9001 Quality Certification is important, it is mandatory to verify and/or (re)calibrate the products periodically. In many cases this service can be provided under in-situ conditions, and the results will be traceable to the relevant international quality standards.

SEMINARS AND TRAINING

Brooks Instrument can provide customer seminars and dedicated training to engineers, end users, and maintenance persons. *Please contact your nearest sales representative for more details.* Due to Brooks Instrument's commitment to continuous improvement of our products, all specifications are subject to change without notice.



TRADEMARKS

Brooks Brooks Instrument, LLC
All other trademarks are the property of their respective owners.

Data-Sheet-GF100-EN/2025-04

Global Headquarters

Brooks Instrument
407 West Vine Street
Hatfield, PA
19440-0903 USA

Toll-Free (USA): 888-554-FLOW
T: 215-362-3500

BrooksAM@BrooksInstrument.com

A list of all Brooks Instrument locations and contact details can be found at www.BrooksInstrument.com

© Copyright 2025 Brooks Instrument, LLC All rights reserved. Printed in U.S.A.