

Installation and Operation Manual

X-DPT-DeviceNet-SLA5800-SLAMf-Series-RevB-MFC-eng

Part Number: 541B190AAG

April, 2014

Supplemental Manual for Brooks[®] DeviceNet[™] MFCs/MFMs

For SLA5800 & SLAMf Series



Essential Instructions

Read this page before proceeding!

Brooks Instrument designs, manufactures and tests its products to meet many national and international standards. Because these instruments are sophisticated technical products, you must properly install, use and maintain them to ensure they continue to operate within their normal specifications. The following instructions must be adhered to and integrated into your safety program when installing, using and maintaining Brooks Products.

- Read all instructions prior to installing, operating and servicing the product. If this instruction manual is not the correct manual, please see back cover for local sales office contact information. Save this instruction manual for future reference.
- If you do not understand any of the instructions, contact your Brooks Instrument representative for clarification.
- Follow all warnings, cautions and instructions marked on and supplied with the product.
- Inform and educate your personnel in the proper installation, operation and maintenance of the product.
- Install your equipment as specified in the installation instructions of the appropriate instruction manual and per applicable local and national codes. Connect all products to the proper electrical and pressure sources.
- To ensure proper performance, use qualified personnel to install, operate, update, program and maintain the product.
- When replacement parts are required, ensure that qualified people use replacement parts specified by Brooks Instrument.
- Unauthorized parts and procedures can affect the product's performance and place the safe operation of your process at risk. Look-alike substitutions may result in fire, electrical hazards or improper operation.
- Ensure that all equipment doors are closed and protective covers are in place, except when maintenance is being performed by qualified persons, to prevent electrical shock and personal injury.

ESD (Electrostatic Discharge)

CAUTION

This instrument contains electronic components that are susceptible to damage by electricity. Proper handling procedures must be observed during the removal, installation, or other handling of internal circuit boards or devices.

Handling Procedure:

1. Power to the unit must be removed.
2. Personnel must be grounded, via a wrist strap or other safe, suitable means before any printed circuit card or other internal device is installed, removed or adjusted.
3. Printed circuit cards must be transported in a conductive container. Boards must not be removed from protective enclosure until immediately before installation. Removed boards must immediately be placed in protective container for transport, storage or return to factory.

Comments:

This instrument is not unique in its content of ESD (electrostatic discharge) sensitive components. Most modern electronic designs contain components that utilize metal oxide technology (NMOS, SMOS, etc.). Experience has proven that even small amounts of static electricity can damage or destroy these devices. Damaged components, even though they appear to function properly, exhibit early failure.

Installation and Operation Manual

X-DPT-DeviceNet-SLA5800-SLAMf-Series-RevB-MFC-eng

Part Number: 541B190AAG

April, 2014

Brooks DeviceNet MFCs/MFMs

Dear Customer,

We recommend that you read this manual in its entirety as this will enable efficient and proper use of the DeviceNet MFCs/MFMs. Should you require any additional information concerning the DeviceNet MFCs/MFMs, please feel free to contact your local Brooks Sales and Service Office; see back cover for contact information, or visit us on the web at www.BrooksInstrument.com. We appreciate this opportunity to service your fluid measurement and control requirements, and trust that we will be able to provide you with further assistance in future.

Yours sincerely,

Brooks Instrument

Brooks DeviceNet MFCs/MFMs

*THIS PAGE WAS
INTENTIONALLY
LEFT BLANK*

Contents

1. Introduction.....	1
2. Before Starting.....	3
2.1. Background & Assumptions	3
2.2. Compliance.....	3
2.3. Notations.....	4
2.3.1. Numbers	4
2.3.2. EPATH.....	4
3. Quick Start.....	5
3.1. Step 1: Set Baud Rate and MAC ID	5
3.1.1. Baud Rate.....	5
3.1.2. MAC ID	6
3.2. Step 2: Configure Scanner	7
3.3. Step 3: Plumb to the Device.....	9
3.4. Step 4: Connect Device to the Network	9
3.4.1. Interface Connector	9
3.5. Step 5: Apply Power to the Network.....	10
3.6. Step 6: LED Verification	10
3.7. Step 7: Begin Scanning the Network.....	11
3.8. Step 7: Normal Operation.....	11
4. Configuration	13
4.1. Commonly Configured Attributes.....	13
4.1.1. I/O Assemblies	14
4.1.2. The “Inferred” Data Type	15
4.1.3. Data Type	16
4.1.4. Data Units.....	17
4.1.4.1. Counts	18
4.1.4.2. Common Device Data Units	18
4.1.5. Safe State (i.e. Safe Mode)	19
4.1.5.1. The State Machine and Safe Mode.....	19
4.1.5.2. Valve Safe Mode	20
4.1.5.3. Flow Sensor Safe Mode	20
4.1.6. Gas Calibration Selection.....	20

Brooks DeviceNet MFCs/MFMs

5. Detailed Configuration	23
5.1. Identity Object [0x1]	25
5.1.1. Attributes	25
5.1.1.1. Note: Device Type	26
5.1.1.2. Note: Revision	26
5.1.1.3. Note: Status	27
5.1.1.4. Note: Serial Number	27
5.1.2. Services	28
5.1.2.1. Service Details	28
5.1.2.1.1. Reset	28
5.2. Message Router Object [0x2]	29
5.2.1. Attributes	29
5.2.2. Services	30
5.2.3. Service Details	30
5.3. DeviceNet Object [0x3]	31
5.3.1. Rules Governing Master/Slave Connections	31
5.3.2. Attributes	32
5.3.2.1. Note: MAC ID	33
5.3.2.2. Note: Baud Rate	33
5.3.2.3. Note: MAC ID Switch Changed	34
5.3.2.4. Note: Baud Rate Switch Changed	34
5.3.2.5. Note: BOI	34
5.3.2.6. Note: Allocation Information	34
5.3.3. Services	35
5.3.4. Service Details	35
5.3.4.1. Allocate Master/Slave Connection	35
5.3.4.2. Release Master/Slave Connection	36
5.4. Assembly Object [0x4]	37
5.4.1. Services	38
5.4.2. Service Details	38
5.5. Connection Object [0x5]	39
5.5.1. Rules Governing Master/Slave Connections [0x5]	39
5.5.2. Attributes	39
5.5.2.1. Explicit Connection Attributes	40
5.5.2.2. Poll I/O Connection Attributes	41
5.5.2.3. Note: State	43
5.5.2.4. Note: Transport Class & Trigger	43
5.5.2.5. Note: Initial Comm. Characteristics	44
5.5.2.6. Note: Watchdog Timeout Action	45
5.5.3. Services	45
5.5.4. Service Details	46
5.6. S-Device Supervisor Object [0x30]	46

5.6.1. Attributes	46
5.6.1.1. Note: Software Revision Level	50
5.6.1.2. Note: Device Status	51
5.6.1.3. Note: Exception Status	51
5.6.1.4. Note: Exception Detail Alarm – Common Exception Detail.....	52
5.6.1.5. Note: Exception Detail Alarm – Device Exception Detail	52
5.6.1.6. Note: Exception Detail Alarm – Manufacturer Exception Detail.....	52
5.6.1.7. Note: Exception Detail Warning – Common Exception Detail	53
5.6.1.8. Note: Exception Detail Warning – Device Exception Detail	53
5.6.1.9. Note: Exception Detail Warning – Manufacturer Exception Detail.....	53
5.6.2. Services	53
5.6.2.1. Service Details.....	54
5.6.2.1.1. Perform Diagnostics	54
5.7. S-Analog Sensor Object [0x31]	55
5.7.1. Attributes	55
5.7.1.1. Note: Data Type	58
5.7.1.2. Note: Data Units	58
5.7.1.3. Note: Status	58
5.7.1.4. Note: Full Scale	59
5.7.1.5. Note: Safe State	59
5.7.1.6. Note: Gas Calibration Object Instance	60
5.7.1.7. Note: Alarms.....	60
5.7.1.8. Note: Warnings.....	60
5.7.1.9. Flow Totalizer and Flow Hours Process.....	61
5.7.2. Services.....	62
5.7.2.1. Service Details.....	63
5.7.2.1.1. Set Full Scale Counts.....	63
5.8. S-Analog Actuator Object [0x32]	63
5.8.1. Attributes	63
5.8.1.1. Note: Data Type	65
5.8.1.2. Note: Data Units	65
5.8.1.3. Note: Override	66
5.8.1.4. Note: Valve	66
5.8.1.5. Note: Status.....	67
5.8.1.6. Note: Safe State	67
5.8.1.7. Note: Alarms.....	67
5.8.1.8. Note: Warnings.....	68
5.8.2. Services	68
5.8.2.1. Service Details.....	68
5.9. S-Single Stage Controller Object [0x33].....	69
5.9.1. Attributes	69
5.9.1.1. Note: Data Type	72
5.9.1.2. Note: Data Units	72
5.9.1.3. Note: Status	72
5.9.1.4. Note: Alarms.....	73

Brooks DeviceNet MFCs/MFMs

- 5.9.1.5. Note: Warnings.....73
- 5.9.1.6. Note: PID Gains.....73
- 5.9.2. Services.....74
 - 5.9.2.1. Service Details.....74
- 5.10. S-Gas Calibration Object [0x34].....75
 - 5.10.1. Attributes75
 - 5.10.1.1. Note: Gas Standard Number.....77
 - 5.10.1.2. Note: Gas Correction Factor77
 - 5.10.1.3. Note: Gas Correction Type.....77
 - 5.10.1.4. Note: Customer Full Scale77
 - 5.10.2. Services.....78
 - 5.10.2.1. Service Details.....78
 - 5.10.2.1.1. Get All Instances78
- 6. Troubleshooting81**
- 7. Appendix83**
 - 7.1. Appendix A - Assembly Object Detail.....83
 - 7.1.1. Assembly Details84
 - 7.2. Appendix B - Data Type Definitions92
 - 7.3. Appendix C – Data Units93
 - 7.4. Appendix D - LED Flash Codes.....96
 - 7.5. Appendix E – Service Summary and Details.....97
 - 7.6. Appendix F - State98
 - 7.7. Appendix G - EDS Parameter Configuration.....101
 - 7.7.1. Flow Sensor Group.....102
 - 7.7.1.1. Flow Sensor Safe State Values.....102
 - 7.7.2. Valve Group.....103
 - 7.7.2.1. Valve Safe State Values.....103
 - 7.7.2.2. Valve Override.....104
 - 7.7.3. Flow Control Group104
 - 7.7.4. Polled Connection Group105
 - 7.7.5. Device Info Group.....105
 - 7.7.6. Soft Start (Ramp) Control Group106
 - 7.7.7. Alarms/Warnings Group ¹106
- 8. Glossary109**

Tables

Table 3-1 I/O Data Description	7
Table 3-2 *Status	8
Table 3-3 **Flow	8
Table 3-4 ***Setpoint	8
Table 4-1 Commonly Configured Attributes/Parameters.....	14
Table 4-2 Attributes to Configure Default Assemblies.....	15
Table 4-3 Configurable Data Type Attributes	17
Table 4-4 Configurable Data Units Attributes	17
Table 4-5 Safe State	20
Table 4-6 Safe Value	20
Table 5-1 Accessible Classes	24
Table 5-2 Identity Object Instance 0 Attributes	25
Table 5-3 Identity Object Instance 1 Attributes	25
Table 5-4 Identity Object [0x1] Status	27
Table 5-5 Identity Object Instance 0 Services	28
Table 5-6 Identity Object Instance 1 Services	28
Table 5-7 Reset Service Arguments.....	28
Table 5-8 Reset Service Response.....	28
Table 5-9 Message Router Instance 0 Attributes	29
Table 5-10 Message Router Instance 1 Attributes	29
Table 5-11 Message Router Instance 0 Services	30
Table 5-12 Message Router Instance 1 Services	30
Table 5-13 DeviceNet Object Instance 0 Attributes	32
Table 5-14 DeviceNet Object Instance 1 Attributes	32
Table 5-15 Baud Rate Values	33
Table 5-16 BOI Values	34
Table 5-17 Allocation Information.....	34
Table 5-18 DeviceNet Object Instance 0 Services.....	35
Table 5-19 DeviceNet Object Instance 1 Services.....	35
Table 5-20 Allocate Service Arguments	35
Table 5-21 Allocation Choice Byte Values	36
Table 5-22 Allocate Service Response	36
Table 5-23 Release Service Arguments.....	36
Table 5-24 Release Choice Byte Value.....	36
Table 5-25 Release Service Response	36
Table 5-26 Assembly Object Instance 0 Attributes	37
Table 5-27 Assembly Object Instance 1..n Attributes	37
Table 5-28 Assembly Object Instance 0 Services.....	38
Table 5-29 Assembly Object Instance 1..n Services.....	38
Table 5-30 Connection Object Instance 0 Attributes	39
Table 5-31 Instance 1 - M/S Explicit Connection Attributes	40
Table 5-32 Instance 2 - M/S Polled I/O Connection Attributes.....	41
Table 5-33 Rules Governing Master/Slave Connections [0x5]	43
Table 5-34 Bit Descriptions	43
Table 5-35 Direction	43
Table 5-36 Production Trigger.....	43
Table 5-37 Transport Class	44

Brooks DeviceNet MFCs/MFMs

Table 5-38 Bit Descriptions	44
Table 5-39 Initial Production Characteristics	44
Table 5-40 Initial Consume Characteristics	44
Table 5-41 Watchdog Timeout Action	45
Table 5-42 Connection Object Instance 0 Services	45
Table 5-43 Connection Object Instance 1 Services	45
Table 5-44 S-Device Supervisor Instance 0 Attributes	46
Table 5-45 S-Device Supervisor Instance 1 Attributes	46
Table 5-46 Device Status	51
Table 5-47 Exception Status	52
Table 5-48 Alarm – Common Exception Detail	52
Table 5-49 Alarm – Device Exception Detail	52
Table 5-50 Alarm – Manufacturer Exception Detail	52
Table 5-51 Warning – Common Exception Detail	53
Table 5-52 Warning – Device Exception Detail	53
Table 5-53 Warning – Manufacturer Exception Detail	53
Table 5-54 S-Device Supervisor Instance 0 Services	53
Table 5-55 S-Device Supervisor Instance 1 Services	54
Table 5-56 Diagnostics Service Arguments	54
Table 5-57 Test ID	54
Table 5-58 Diagnostic Service Response	54
Table 5-59 S-Analog Sensor Instance 0 Attributes	55
Table 5-60 S-Analog Sensor Instance 1 Attributes	55
Table 5-61 Status	58
Table 5-62 Full Scale	59
Table 5-63 Safe State	59
Table 5-64 S-Analog Sensor Instance 0 Services	62
Table 5-65 S-Analog Sensor Instance 1 Services	62
Table 5-66 Set Full-Scale Counts Service Arguments	63
Table 5-67 Set Full-Scale Counts Service Response	63
Table 5-68 S-Analog Actuator Instance 0 Attributes	63
Table 5-69 S-Analog Actuator Instance 1 Attributes	64
Table 5-70 Override	66
Table 5-71 Status	67
Table 5-72 Safe State	67
Table 5-73 S-Analog Actuator Instance 0 Services	68
Table 5-74 S-Analog Actuator Instance 1 Services	68
Table 5-75 S-Single Stage Controller Instance 0 Attributes	69
Table 5-76 S-Single Stage Controller Instance 1 Attributes	70
Table 5-77 Status	72
Table 5-78 S-Single Stage Controller Instance 0 Services	74
Table 5-79 S-Single Stage Controller Instance 1 Services	74
Table 5-80 S-Gas Calibration Instance 0 Attributes	75
Table 5-81 S-Gas Calibration Instance 1..n Attributes	75
Table 5-82 Gas Correction Type	77
Table 5-83 S-Gas Calibration Instance 0 Services	78
Table 5-84 S-Gas Calibration Instance 1..n Services	78
Table 5-85 Get All Instances Arguments	78
Table 5-86 Get All Instances Response	79
Table 7-1 Summary Table of Input Assemblies	83

Table 7-2 Summary Table of Output Assemblies.....	83
Table 7-3 Input Assembly 1	84
Table 7-4 Input Assembly 2	84
Table 7-5 Input Assembly 3	84
Table 7-6 Input Assembly 4	85
Table 7-7 Input Assembly 5	85
Table 7-8 Input Assembly 6	86
Table 7-9 Output Assembly 7	86
Table 7-10 Output Assembly 8	86
Table 7-11 Input Assembly 13	87
Table 7-12 Input Assembly 14	87
Table 7-13 Input Assembly 15	88
Table 7-14 Input Assembly 16	88
Table 7-15 Input Assembly 17	89
Table 7-16 Input Assembly 18	90
Table 7-17 Output Assembly 19	91
Table 7-18 Output Assembly 20	91
Table 7-19 Data Types	92
Table 7-20 Volumetric Flow Units.....	93
Table 7-21 Mass Flow Units	95
Table 7-22 Actuator Units	95
Table 7-23 NET LED Flash Codes	96
Table 7-24 MOD LED Flash Codes.....	96
Table 7-25 Get Attribute Single Service Parameters	97
Table 7-26 Success Response Data	97
Table 7-27 Set Attribute Single Service Parameters.....	97
Table 7-28 Success Response Data	97
Table 7-29 S-Device Supervisor State Event Matrix	99
Table 7-30 Parameter Groups	101
Table 7-31 Supported Flow Sensor Parameters	102
Table 7-32 Flow Sensor Safe State Values	102
Table 7-33 Supported Valve Parameters	103
Table 7-34 Valve Safe State Values.....	103
Table 7-35 Valve Override Values.....	104
Table 7-36 Supported Flow Control Parameters.....	104
Table 7-37 Polled Connection Values	105
Table 7-38 Supported Device Info Parameters	105
Table 7-39 Supported Soft Start Parameters	106
Table 7-40 Alarms/Warnings	106

Figures

Figure 3-1 Baud Rate Switch.....	5
Figure 3-2 MAC ID Switches	6
Figure 3-3 Interface Connector.....	9
Figure 3-4 View Showing Top of MFC/MFM Can.....	10
Figure 7-1 S-Device Supervisor State Machine Diagram.....	98

*THIS PAGE WAS
INTENTIONALLY
LEFT BLANK*

1. Introduction

Many applications of Flow Meters/Controllers and Pressure devices are moving to increasing the use of automation. Automation comes in many forms: PLC's (Programmable Logic Controllers), DCS's (Distributed Control Systems), and PC-based solutions. Digital communications from these varied automation systems and the devices they measure and control are a very effective means of not only accomplishing more effective and rapid system integration, but also providing greatly improved system diagnostics and maintainability. DeviceNet™ is an open digital protocol capable of high speeds and easy system connectivity. Brooks Instrument has several of its devices available on this popular networking standard, and is a member of ODVA™ (Open DeviceNet Vendors Association), the governing standard body for DeviceNet.

*THIS PAGE WAS
INTENTIONALLY
LEFT BLANK*

2. Before Starting

2.1. Background & Assumptions

This manual is a supplement to the SLA5800 Series Mass Flow Controller Operation Manual. It is assumed that the owner of this SLA5800 Series MFC is thoroughly familiar with the theory and operation of a SLA5800 Series MFC/ MFM. If not, it is recommended that the owner read the Operations Manual first before continuing with this supplement.

This manual assumes a basic knowledge and understanding of the DeviceNet protocol, its topology and its method of logically accessing the data or parameters contained within a device. This manual also assumes basic knowledge and understanding regarding the operation of Mass Flow Controllers or Mass Flow Meters. This manual is not intended to be a replacement to the ODVA (Open DeviceNet Vendors Association) specification, which is still the authoritative definition and description of DeviceNet communications. It is recommended, but not required for the purposes of this manual, that the user obtain a copy of the DeviceNet specification from ODVA (<http://www.odva.org/>).

This manual does not make any assumptions about any particular manufacturer of equipment or custom software used by the user to communicate with the Brooks device, but assumes the user has thorough understanding of such equipment and any configuration software.

2.2. Compliance

The SLA5800 Series Mass Flow Controller (MFC) or Mass Flow Meter (MFM) conforms to the ODVA specified Device Profile for a Mass Flow Controller device (see: ODVA Specification Volume 1, Section 6-31). The SLA5800 Series MFC/MFM device has been operationally certified by ODVA at the Conformance Test Lab in Ann Arbor, Michigan. The test verified that the device conforms to all specifications required of a DeviceNet capable device, the Mass Flow Controller Profile (0x1A) and its supporting objects. Additionally the Mass Flow Controller and Mass Flow Meter devices have been certified through ODVA to conform to the Semiconductor Special Interest Groups (Semi-Sig) standards and tests.

2.3. Notations

This section details notations and conventions used throughout the manual. It is recommended that the reader become very familiar with these conventions. Hypertext links are used in the manual to assist in navigating. This manual is best viewed in its electronic form and can be obtained from the Brooks Customer Service Department ([Flow Meter](#), [Flow Controller](#), [Level Measurement Documentation](#)) in Adobe[®] Acrobat[®] PDF format. A glossary is provided for reference in Section: 8 Glossary to aid in reviewing and/or to define any unfamiliar terms.

2.3.1. Numbers

Numeric values used throughout this manual will be clearly denoted as to the base numeric system it represents. All hexadecimal numbers (base 16) will be prefixed with a 0x, like 0xA4. All binary numbers (base 2) will be suffixed with a b, like 1001b. All other numbers not annotated this way will be assumed decimal (base 10).

2.3.2. EPATH

EPATH's will be denoted within brackets [], like [0x31, 1, 3], which represents, left to right, the Class ID (hexadecimal), Instance ID (decimal), and Attribute ID (decimal).

3. Quick Start

This section assumes the owner of the SLA5800 Series device has a fully operational and trouble-free communications network with appropriate power supplies as defined in the DeviceNet specification. This section also assumes that there exists, connected to the network, a “master” type of device with Poll I/O scanning capability (generally this is the most common application for a DeviceNet network).

3.1. Step 1: Set Baud Rate and MAC ID

Two sets of switches are provided for setting the communication baud rate and for setting the MAC ID of the device. The default MAC-ID is 63. Set these switches on the MFC(s) to the desired values.

3.1.1. Baud Rate

The switch labeled “RATE” sets the baud rate of the MFC. Possible values along with their corresponding label are (see figure below): “1” = 125K baud, “2” = 250K baud, and “5” = 500K baud, “P” = Software programmable where DeviceNet communications may be used to set the baud rate to one of the above values. The out-of-box default setting is 500K baud.

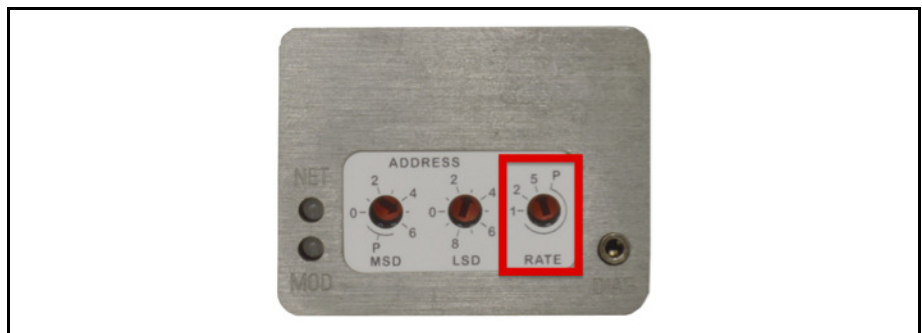

Figure 3-1 Baud Rate Switch

Brooks DeviceNet MFCs/MFMs

3.1.2. MAC ID

Two switches labeled with “ADDRESS” are used to configure the MAC ID of the device. MAC ID stands for Media Access Control Identifier and is used to set the unique address of the device on the network. The possible range of addresses is 00 to 63¹.

The switch labeled “MSD” is used to set the most significant digit of the address: 00, 10, 20, 30, ..., etc., up to 60. If “MSD” is set in the range labeled as “P” this indicates the MAC ID of the device is software programmable and must be set through the network.

The switch labeled “LSD” sets the least significant digit of the MAC ID. The out-of-box default setting for the MAC ID is 63.

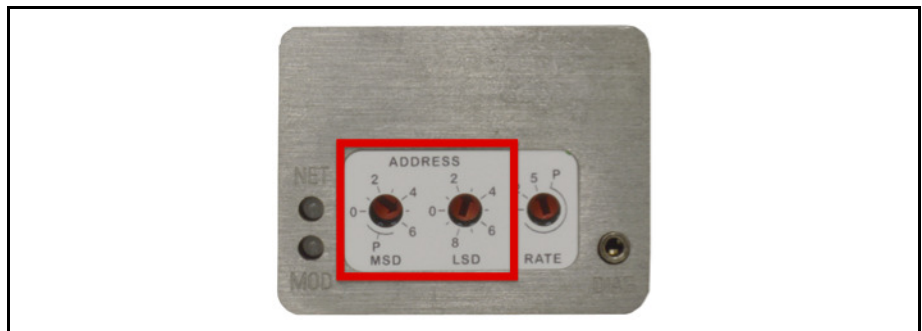

Figure 3-2 MAC ID Switches

NOTE:

Any changes made to the MAC ID or Baud Rate values, either by externally setting them or through software, will not take effect until the device has been power cycled.

¹ MAC ID 63 is reserved by ODVA as a commissioning node address and should not be used operationally during the execution of a process.

3.2. Step 2: Configure Scanner

This section contains information that will be needed to configure the scanning device (e.g. PLC, PC, DCS). You will need to consult the documentation for these systems for proper configuration to the device configuration information below.

The SLA5800 Series MFC/MFM comes from the factory with a default configuration as defined by the MFC/MFM Device Profile. The table below lists attributes that are of the most interest to owners of this type of device and the factory configured default values. For more information on all the supported attributes in the device, see Section 5: Detailed Configuration.

NOTE:

If you ordered your SLA5800 Series MFC/MFM and requested that the Factory pre-configure the device per your own custom specification, the following tables may not apply.

The default assemblies used for Poll I/O communications.

Table 3-1 I/O Data Description

Input Assembly		Output Assembly	
Assembly Instance	2	7	
Data Size	3 bytes	2 bytes	
Assembly Type	Input	Output	
Definition of Bytes			
Byte 0	Status*	Byte 0	Setpoint***
Byte 1	Flow**	Byte 1	
Byte 2		N/A	

Status is defined as an 8-bit bitfield whose bits have the following definition.

Brooks DeviceNet MFCs/MFMs

Table 3-2 *Status

Bit	Description
0	Common Alarms
1	Device Profile Specific Alarms
2	Manufacturer Specific Alarms
3	0
4	Common Warnings
5	Device Profile Specific Warnings
6	Manufacturer Specific Warnings
7	1 (Extended Reporting Enabled)

Flow is defined as a 16-bit signed integer (-32768 to 32767) to represent flow in data units of counts¹.

The numeric range definitions for Flow are:

Table 3-3 **Flow

Counts Range	< 0	0 - 24576	24577 - 27033	27034 - 32767
Flow	Reverse Flow	0% to 100% of Full Scale	100+% to 110% of Full Scale	110+% to 133% of Full Scale

Setpoint is defined as a 16-bit signed integer (-32768 to 32767) to represent the setpoint value in data units of counts¹.

The numeric range definitions for Setpoint are:

Table 3-4 ***Setpoint

Counts Range	< 0	0 – 24576	24577 -27033	27034 - 32767
Setpoint	Not Valid. The minimum value for setpoint will be clamped to 0% of Full Scale	0% to 100%of Full Scale	100+% to 110% of Full Scale	Not Valid. The maximum value for setpoint will be clamped to 110% of Full Scale

¹ The Data Units Counts is a dimensionless unit that defines a range of numbers to represent a quantity. See Configuration Section for more information on Data Units counts.

¹ The Data Units Counts is a dimensionless unit that defines a range of numbers to represent a quantity. See Configuration Section for more information on Data Units counts.

3.3. Step 3: Plumb to the Device

Ensure gas flow paths are provided to the inlet and outlet connectors of the MFC. Ensure pressures are per the specifications stated on the purchase order for the device (or the calibration data sheet shipped with the device).

3.4. Step 4: Connect Device to the Network

Connect the device to the network by attaching the network cable to the DeviceNet M12 connector on the side of the device. If power has already been applied to the network, go to Step 6.

3.4.1. Interface Connector

Power and network signals are interfaced to the MFC through the standard 5-pin M12 connector on the device. This connector is specified in the DeviceNet Specification, Vol. 1, Appendix C-5, Errata 5 and is defined as a male, sealed, micro-style connector. The figure below illustrates the electrical connections to the device.

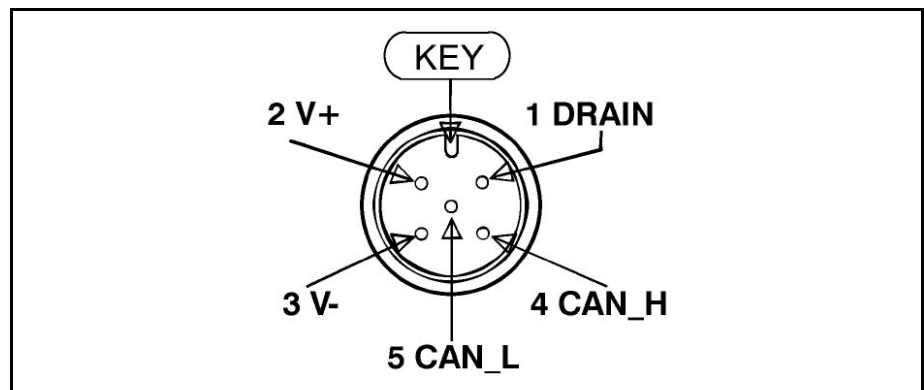

Figure 3-3 Interface Connector

Brooks DeviceNet MFCs/MFMs

3.5. Step 5: Apply Power to the Network

A DeviceNet network is powered by a (nominal) +24 VDC supply. Ensure that your network is properly powered per the ODVA specifications. Reference DeviceNet Specification, Edition 3.14, Volume 3, Section 8.5, for the power supply specification.

3.6. Step 6: LED Verification

Two LED's are provided to indicate network status and module status, labeled "NET" and "MOD" respectively. Appendix D provides a table of flash codes for each of the LED's.



Figure 3-4 View Showing Top of MFC/MFM Can

When power is applied to the device, each LED will flash red, then green a minimum of one time. This is a LED verification test. If this does not occur, go to the Troubleshooting section.

Next the MOD LED ("Module" Status) will then begin to flash red/green indicating that the device is self-testing. When all internal tests have passed, the MOD LED will turn solid green. If this does not occur, go to the Troubleshooting section.

The NET LED ("Network" Status) will remain off until another node is connected to the network and completes a Duplicate MAC ID check. This implies that under normal operating conditions after the initial NET LED power on sequence has completed the lonely node will never turn on its NET LED.

Once the device is connected to a network of devices the NET LED (“Network” Status) should flash green. This will indicate that the device MAC ID and Baud Rate are configured properly and the device recognizes the network. It is now capable of establishing “connections.” Proceed to Step 7.

If the NET LED is solid green, an active connection has now been established to the device. Proceed to Step 7.

If the NET LED is indicating any other status than those described above, consult Appendix D for LED flash codes or go to the Troubleshooting section.

3.7. Step 7: Begin Scanning the Network

Enable the scanner to begin scanning the network. If the NET LED on the MFC goes to solid green, the scanner has connected to the MFC and is now actively polling the MFC. Each poll request to the MFC contains a setpoint value, and each poll response from the MFC contains Status and Flow information assuming default I/O assembly. If the NET LED does not maintain a solid green status while the scanner is actively scanning the network, consult Appendix D for LED flash codes or go to the Troubleshooting section.

3.8. Step 7: Normal Operation

During normal operation the device will change states between either the Idle or Executing states. The current state of the device can be determined by inspecting the Device Status attribute from the S-Device Supervisor Instance 1 [0x30-1-11]. A value of 2 indicates the device is in the Idle state and a value of 4 indicates the device is in the Executing state.

The device will be in its safe mode when Idle and the control loop for control type devices will be inactive. The device can be transitioned into the Executing state by either sending the S-Device Supervisor a Start service or when the first valid Poll I/O data is received.

4. Configuration

4.1. Commonly Configured Attributes

The SLA5800 Series MFC/MFM supports many different configurable attributes. The out-of-box defaults meet the needs of a great majority of applications, but some applications may require the device to report more information or behave differently than is configured with default settings, such as valve position, safe mode, or flow and/or setpoint as real numbers in engineering units etc.

This section covers the more common attributes that are configured to meet the unique needs of applications. The terms “attribute” and “parameters” can be used interchangeably and ultimately refer to the same data item within the MFC device. The term “parameter” is widely used within the EDS paradigm whereas “attribute” is used within the DeviceNet specification.

The tables will make reference to both the EDS Parameter name (if the configuration software utilizes the EDS sheet) and the EPATH descriptor (class-instance-attribute) for those who are writing custom or have other types of configuration interfaces.

The following table lists attributes/parameters that will be discussed in this section.

Brooks DeviceNet MFCs/MFMs

Table 4-1 Commonly Configured Attributes/Parameters

Attribute	EDS ¹ Parameter	EPATH	Default	Semantics
Default Polled I/O Conn. Produce Assembly Instance	Poll Prod Assy	[0x5-1-100]	2	Uses Assembly Instance 2 to Produce Data onto the network
Default Polled I/O Consume Assembly Instance	Poll Cons Assy	[0x5-1-101]	7	Uses Assembly Instance 7 to Consume Data from the network
Sensor Data Type	Flow Sensor Data Type	[0x31-1-3]	0xC3	Flow will be reported as a 16-bit signed integer
Actuator Data Type	Valve Data Type	[0x32-1-3]	0xC3	Valve position will be reported as a 16-bit signed integer
Setpoint Data Type	Flow Control Data Type	[0x33-1-3]	0xC3	Setpoint will be reported as a 16-bit signed integer.
Sensor Data Units	Flow Sensor Data Units	[0x31-1-4]	0x1001	See Counts Description See Counts Range Values
Actuator Data Units	Valve Data Units	[0x32-1-4]	0x1001	See Counts Description See Counts Range Values
Setpoint Data Units	Flow Control Data Units	[0x33-1-4]	0x1001	See Counts Description See Counts Range Values
Sensor Safe State	Flow Sensor Safe State	[0x31-1-25]	0	The sensor will report a value of 0 when device is in its Safe State
Actuator Safe State	Valve Safe State	[0x32-1-21]	0	The valve will close when device is in its Safe State
Selected Gas Calibration	Flow Sensor Gas Cal Instance	[0x31-1-35]	1	The instance of the Gas Calibration Object used to linearize the Flow Sensor

¹See Appendix G - EDS Parameter Configuration on p. 101 for a complete list of EDS parameters.

4.1.1. I/O Assemblies

Assemblies are a collection of attributes and are an integral part of the I/O data exchange. It is the Assembly that defines what data and how much data is exchanged between the Master and the device in an I/O type of connection. Assemblies are grouped into two categories: Input and Output

From a device perspective, an Input Assembly is the data PRODUCED from the device ONTO the network (or can also be viewed as data "INPUT" to the Master FROM the device). Again, from a device perspective, an Output Assembly is the data CONSUMED from the network INTO the device (or can also be viewed as the data "OUTPUT" from the Master TO the device).

A selection of pre-defined Assemblies is listed in Appendix A. Once the desired Assemblies have been configured in the device, corresponding changes in configuration will probably be required from the Master side of the connection.

NOTE:

For I/O Connections to be established between Master and Slave devices the masters I/O Production data sizes must match the slaves I/O Consume data size and the masters I/O Consume data size must match the slaves Produce data size. Selection of an Assembly in the MFC device automatically sets the I/O data sizes and no further configuration by the customer is required.

The table below references the parameters/attributes associated with I/O Assembly configuration.

Table 4-2 Attributes to Configure Default Assemblies

EDS Parameter	EPATH	Configures Connection Type	Valid Assembly Type	Data Size (Bytes)	Out-of Box Default
Poll Prod Assy	[0x5-1-100]	Polled	Input	3	2
Poll Cons Assy	[0x5-1-101]	Polled	Output	2	7

4.1.2. The “Inferred” Data Type

It is difficult to talk about I/O Assemblies without talking about Data Type since both are tied very closely together (For more detailed explanation on Data Type, see section below “Data Type”).

The Assembly Object is a collection of parameters/attributes. The purpose being that one can move a grouping of data to many attributes at one time as opposed to using individual messages to get or set each attribute. A difficulty occurs when one or more of the attributes in the Assembly have a changeable or dynamic data type. For example, the attribute Flow in the S-Analog Sensor object has data type that is dependent on the value of attribute Data Type within the same object.

The Assembly objects defined in the MFC device profile are considered static, meaning that the number of bytes defined in the Assembly is the number of bytes that will be transferred, no more, no less.

Brooks DeviceNet MFCs/MFMs

Example:

S-Analog Sensor object's Data Type (Flow Sensor Data Type parameter) is configured to REAL and Assembly object Instance 1 is used to produce the flow data. The size of data type REAL is 4 bytes and therefore Flow will be reported as 4 bytes, but Assembly Instance 1 reports flow as 2 bytes. A data size mismatch/conflict has occurred. When a data size mismatch occurs, the Master device usually indicates this condition with an error.

The solution is to force the Data Type attribute (Flow Sensor Data Type parameter) to match the "inferred" data type of the Assembly instance. A mechanism is in place such that if an Assembly object has been assigned to an I/O Connection AND the I/O Connection becomes active (transitions to the Established state), the attribute/parameter that defines the data type for the particular object will be forced automatically to the inferred data type of the Assembly.

Example:

In the example above, attribute Data Type (Flow Sensor Data Type parameter) of the S-Analog Sensor Object will be changed to INT (same as the Assembly), enforcing the data size match between the Flow data and the Assembly instance.

NOTE:

While the I/O Connection is active, the Data Type parameter/attribute will have "get only" accessibility, effectively locking out any means of modifying the attribute, including the establishment of another I/O Connection, until the original I/O Connection is terminated.

4.1.3. Data Type

The Data Type of an attribute defines the way a data value is represented in the MFC and transmitted across the network, such as integer and floating point. Most of the attributes defined in the MFC have a static data type, meaning the data type for that attribute is defined once and never changes.

Several of the key attributes in the MFC have a dynamic data type that is defined and configurable via a companion attribute. Flow in the S-Analog Sensor object (Flow Sensor Parameter) has a companion attribute to define Flow's data type. Some other key attributes with dynamic data type are Setpoint and Valve Position. It may be desirable when changing Data Units (see Data Units section below) to also change the Data Type. For example, if Flow and Setpoint are configured to represent Data Units "Percent", then Data Type INT would limit the values to whole numbers from 0 to 100. Therefore, the smallest increment of flow/setpoint would be 1. However, if Data Type was set to REAL, Flow/Setpoint could now be floating point numbers between 0.00000 to 100.000.

The following table lists objects and their attributes associated with configuring data type.

Table 4-3 Configurable Data Type Attributes

EDS Parameter	EPATH	Applicable Units Table	Out-of Box Default
Flow Sensor Data Type	[0x31-1-3]	Appendix B - Data Type Definitions	INT
Valve Data Type	[0x32-1-3]	Appendix B - Data Type Definitions	INT
Flow Control Data Type	[0x33-1-3]	Appendix B - Data Type Definitions	INT

NOTE:

The two data types supported by the SLA5800 Series MFC for the dynamic data typed attributes are INT and REAL. An INT is a number that is represented by whole numbers ranging from 32767 to -32768. A REAL is a floating-point number ranging from 3.4E38 to -3.4E38.

4.1.4. Data Units

The SLA5800 Series MFC is capable of reporting flow and accepting setpoints in values associated to engineering units. This can simplify user interpretation of information from the device by letting the device perform the calculations necessary to interpret the flow signal from its internal sensor based upon information in the selected calibration. Though some may be more familiar with Counts or Percent from using Analog type MFC's, the interpretation of Counts (see section Counts below and Range Definition in Quick Start) can vary.

The following table lists objects and their attributes associated with data units. Data Units attributes have a data type of UINT.

Table 4-4 Configurable Data Units Attributes

EDS Parameter	EPATH	Applicable Units Table	Out-of Box Default
Flow Sensor Data Units	[0x31-1-4]	Appendix C: Volumetric Flow Data Units Table Appendix C: Mass Flow Data Units Table	Counts
Valve Data Units	[0x32-1-4]	Appendix C: Actuator Data Units Table	Counts
Flow Control Data Units	[0x33-1-4]	Appendix C: Volumetric Flow Data Units Table Appendix C: Mass Flow Data Units Table	Counts

Brooks DeviceNet MFCs/MFMs

4.1.4.1. Counts

Counts define a range of number to represent 0 to 100+% of Flow. The problem with this unit is defining what is 100%. In an SLA5800 Series, when configured to use the Data Type INT the range of numbers available to define 0-100% is -32768 to 32767. SLA5800 Series devices force 0% to be 0 Counts, and defaults 100% to 24576 Counts. This 24576 number allows for a flow signal to be indicated as high as 133% of full scale (32767 = 133%). If the user desires to change this upper range number, a service is provided in the S-Analog Sensor object (Set Full Scale Counts) to change this value.

NOTE:

If the value 32767 is used for 100%, be aware that any flow value that exceeds 100% of full scale cannot be indicated. This is a result of the limitation of a 2 byte signed integer number.

4.1.4.2. Common Device Data Units

In order to simplify the management of multiple objects with individual attributes for configuring Data Units the SLA5800 Series device will force a consistent Data Units value. Under certain conditions, upon a change of any one of the configurable Data Units attributes from Table 4.1.4-1 all objects will change to that Data Units type.

The value of Data Units will be changed for all objects in the device if any one of the objects Data Units attributes are changed to Counts or Percent. If an individual objects Data Units is changed to units other than Counts or Percent only that objects Data Units will be affected.

Example:

Upon device power up the Flow Sensor Data Units are set to SCCM, the Actuator Data Units are set to Percent and the Flow Control Data Units are set to SLM. If the Flow Sensor Data Units are changed to Counts all three objects Data Units value will be changed to Counts and their respective process variable values will be reported in Counts.

Subsequently if the Flow Sensor Data Units are set back to SCCM only the Flow Sensor Data Units will be set to SCCM and only the Flow Sensor Value will be reported in SCCM. The Actuator and Controller Data Units will remain set to Counts and their process variables values will be reported in Counts.

4.1.5. Safe State (i.e., Safe Mode)

The Safe State or Safe Mode of the devices means that the device has transitioned to a state that is considered “safe” whereby it will shut down the normal controller process and place mechanical and sensing mechanisms in the device to a safe condition (e.g.. The actuator may be forced closed). The device will ignore input stimuli, such as setpoint or actuator override. In most cases, the safe mode of the device is equivalent to the operational mode when the device is not powered.

NOTE:

Safe State indicates the condition that the sensor, actuator, and controller will be in when the device is in a particular Operational State. The Safe State condition can be configured for each of these elements by setting the appropriate Safe State attribute in each of their corresponding objects (e.g. Analog Sensor Object, Analog Actuator Object, and Single Stage Controller Object) if supported.

4.1.5.1. The State Machine and Safe Mode

All products in the SLA5800 Series product line employ an internal State Machine to govern the operation of the device. The state machine is illustrated with supporting diagrams and transition tables in Appendix F. Within each state, the device can enter a mode that defines an operational behavior. One mode in particular is the Safe Mode (a.k.a. the Safe State).

The device will be in Safe Mode when the device is in any state other than the Executing State. The Executing State can be entered in two ways: first, the establishment and subsequent exchange of non-zero length I/O data through an I/O connection, and second, a directive to the S-Device Supervisor Object using explicit messaging. Likewise, the Executing State will be exited by closing all I/O connections to the device, an I/O Connection timeout (i.e. EPR Timeout), or by a directive to the S-Device Supervisor Object. In addition, a transition out of the Executing State will occur internally by the device if a severe fault condition is detected.

The Safe Modes of the MFC/MFM device is described in the below tables. The label “default” indicates the out-of-the box default defined by the MFC device profile.

Brooks DeviceNet MFCs/MFMs

4.1.5.2. Valve Safe Mode

Attribute Safe State in S-Analog Actuator Object [0x32-1-21], or EDS Parameter Group Valve. These states apply to both Normally Closes and Normally Open Valves

Table 4-5 Safe State

Value	State
0	Closed (default)
1	Open
2	Hold
3	Use Safe Value

4.1.5.3. Flow Sensor Safe Mode

Attribute Safe State in S-Analog Sensor Object [0x31-1-25], or EDS Parameter Group Flow Sensor

Table 4-6 Safe Value

Value	State
0	Zero (default)
1	Full Scale
2	Hold Last Value
3	Use Safe Value
100	Track

4.1.6. Gas Calibration Selection

If the MFC/MFM contains multiple calibrations, the selection of a particular calibration can be configured in attribute "Gas Calibration Object Instance" of the S-Analog Sensor Object [0x31-1-35] or the Parameter Flow Sensor Gas Cal Instance in the Flow Sensor group of parameters.

To obtain a list of all calibrations in the device, service 0x4B, "Get All Instances", of the S-Gas Calibration Object [0x34] can be invoked which will return the list.

The value of this attribute is limited to the number of Flow Calibration Objects configured in the device. The minimum value is 1, which is also the default value.

5. Detailed Configuration

NOTE:

This section is recommended for advance users of DeviceNet and Brooks MFC/MFM products.

This section details all of the Classes, Instances, Attributes and Services supported by the SLA5800 Series MFC/MFM. Differences between the MFC and MFM device types are noted as exceptions in each sub-section. The classes detailed in the following sections can be categorized into the following functional groups to indicate what aspect of the device is being configured:

Communications

Classes in this category define how the device communicates on DeviceNet. A great majority of the information that is accessible is very well defined in the DeviceNet specification and therefore does not require much custom configuration. If the user of this device would like to do custom configuration in this category, it is strongly recommended that the user have a thorough understanding of these classes and DeviceNet protocols. More detail can be found about these classes in the DeviceNet specification.

Data Flow

Classes in this category define how data is moved to and from Application classes to the Communication classes. Again, much of what is detailed in this category is provided for informational purposes and is very limited in its ability to be customized

Application

This category of classes defines how the device is to function. In this case, the attributes in these classes configure the behavior of an MFC/MFM. Of all the categories listed here, this is the most customizable.

The table below lists the classes accessible in the SLA5800 Series MFC/MFM and their associated category. It also indicates if the class is present in either of the MFC or MFM device types.

Brooks DeviceNet MFCs/MFMs

Table 5-1 Accessible Classes

Class	Category	No Of Instances	MFC	MFM
Identity Object [0x1]	Communications	1	Y	Y
Message Router Object [0x2]	Data Flow	1	Y	Y
DeviceNet Object [0x3]	Communications	1	Y	Y
Assembly Object [0x4]	Data Flow	16	Y	Y
Connection Object [0x5]	Communications	2	Y	Y
S-Device Supervisor Object [0x30]	Application	1	Y	Y
S-Analog Sensor Object [0x31]	Application	1	Y	Y
S-Analog Actuator Object [0x32]	Application	1	Y	N/A
S-Single Stage Controller Object [0x33]	Application	1	Y	N/A
S-Gas Calibration Object [0x34]	Application	1–6, depending on the number of calibrations stored in the device	Y	Y

In the ODVA DeviceNet specification, Instance 0 of both attributes and services are referred to as Class Level attributes and services. Instance 1 and higher are referred to as Instance Level attributes and services. This document will refer to all Levels by their instance number to avoid possible confusion.

The following details the meaning of the table heading names:

Attribute ID: The ID number of the attribute.

Name: The ODVA DeviceNet Specification label for the attribute.

Data Type: The ODVA DeviceNet Data Type for this attribute. See Appendix B for the definition of each data type.

Access Rule: “Get” means that the value of this attribute is “Read Only”. “Set” means that the value of this attribute can be read and/or written.

NV: “NV” = The value of the attribute is stored in non-volatile memory and its value will be retained after a power cycle.

V: “V” = The value of the attribute is in volatile memory and its value will be returned to default after a power cycle.

Description: A brief description of the meaning of the attribute.

Notes: Any additional notations of importance about the attribute. These notes will be found in the same section as the table.

5.1. Identity Object [0x1]

The Identity Object contains informational attributes that uniquely describe the device.

Example:

The use of attributes Vendor ID, Device Type, Product Code, and Serial Number together uniquely describe this device from any other device.

5.1.1. Attributes

Table 5-2 Identity Object Instance 0 Attributes

Attrib ID	Name	Data Type	Access Rule	NV	Description	Notes
1	Revision	UINT	Get	V	Revision of the Identity object class definition upon which the implementation is based.	If updates require an increase in this value, then the value of this attribute increases by 1. Range 1– 65535

Table 5-3 Identity Object Instance 1 Attributes

Attrib ID	Name	Data Type	Access Rule	NV	Description	Notes
1	Vendor ID	UINT	Get	NV	ID Number assigned to vendor by ODVA	Brooks Instrument ID = 246
2	Device Type	UINT	Get	NV	Numeric identifier indicating the ODVA Device Profile implemented by the device.	Device Type = 26 See 'Note: Device Type' below
3	Product Code	UINT	Get	NV	Identification of a particular product of an individual vendor.	MFC = 6, MFM = 7
4	Revision	STRUCT of:	Get	NV	Revision of the device the Identity Object represents	See 'Note: Revision' below
	Major Revision	USINT				
	Major Revision	USINT				

Brooks DeviceNet MFCs/MFMs

Table 5-3 Identity Object Instance 1 Attributes (continued)

Attrib ID	Name	Data Type	Access Rule	NV	Description	Notes
5	Status	WORD	Get	V	Summary status of the device.	See 'Note: Status' below
6	Serial Number	UDINT	Get	NV	Serial number of device.	See 'Note: Serial Number' below
7	Product Name	Short String	Get	NV	Human readable Identification.	

5.1.1.1. Note: Device Type

The device profile includes both an Identity and an S-Device Supervisor Objects. Both objects contain an attribute that defines the kind of device this implementation supports. In this object the Device Type is assigned a numeric value of 0x1A . This number corresponds to the device profile ID contained in the ODVA specification. This attribute should not be confused with the S-Device Supervisors Device Type attribute [0x31, 1, 3] which is represented as a DeviceNet Short String.

5.1.1.2. Note: Revision

The ODVA specification defines Major Revision as a significant change to the fit, form, or function of the product. Minor Revision is defined as changes that do not affect user configuration choices such as bug fixes, hardware component change, labeling change, etc.

5.1.1.3. Note: Status

The S-Device Supervisor object has an attribute called Device Status [0x31, 1, 11] that operates in parallel to this attribute and provides additional application information that is not available using this attribute. It is recommended that users use the S-Device Supervisor Device Status attribute for determining the status of the device. The table below defines the valid values that can be returned when reading the Identity Object Status attribute. Note that the Status attribute values are Bit oriented.

Table 5-4 Identity Object [0x1] Status

Bit	Description
0	Set to 1 when the device has been allocated.
1 – 8	Reserved, always zero
9	Minor Recoverable Fault
10	Major Recoverable Fault, S-Device Supervisor object Device Status Attribute = Critical Fault
11-15	Reserved, always zero

5.1.1.4. Note: Serial Number

This Serial Number attribute differs from the S-Device Supervisor Serial Number attribute [0x31, 1, 9] whereby the Identity Object attribute [0x01, 1, 6] is strictly a numeric value that is guaranteed to be unique by the manufacturer across all of the manufacturer’s DeviceNet products. The S-Device Supervisor attribute Serial Number is a string value that should represent the manufacturers method of defining serial numbers for its products.

Furthermore the Semiconductor Special Interest Group (SemiSig) profile dictates the S-Device Supervisor Serial Number string attribute [0x31, 1, 9] and the Identity Serial Number unsigned integer attribute [0x01, 1, 6] match in value. Functionally this requirement limits the string attribute to the range of values that can be stored in an unsigned integer, 0 to 65535. The S-Device Supervisor Serial Number string attribute is defined to contain thirty characters. The string size gives the attribute a value range from 0 to 999,999,999,999,999,999,999,999,999. If the customer requires a string serial number series that exceeds the maximum size of an unsigned integer it is possible the two attributes will not match in value. Under these conditions the S-Device Supervisors string attribute [0x31, 1, 9] value should take precedence over the Identity objects unsigned integers [0x01, 1, 6] value.

Brooks DeviceNet MFCs/MFMs

5.1.2. Services

Table 5-5 Identity Object Instance 0 Services

Service Code	Service Name	Service Description	Details
0x0E	Get Attribute Single	Returns the contents of the specified attribute	Appendix E: Get Attribute Single

Table 5-6 Identity Object Instance 1 Services

Service Code	Service Name	Service Description	Details
0x0E	Get Attribute Single	Returns the contents of the specified attribute	Appendix E: Get Attribute Single
0x05	Reset	Resets the DeviceNet interface of the device.	See 'Service Reset' Details Below

5.1.2.1. Service Details

5.1.2.1.1. Reset

Table 5-7 Reset Service Arguments

Parameter Name	Data Type	Required	Parameter Value	Semantics
Type	USINT	N	0	Emulate as closely as possible cycling power on the item the Identity Object represents. This value is the default if this parameter is omitted (default).
			1	Return as closely as possible to the out-of-box configuration, then as closely as possible emulate cycling power.

Table 5-8 Reset Service Response

Parameter Name	Data Type	Required	Parameter Value	Semantics
NO RESPONSE DATA				

5.2. Message Router Object [0x2]

The Message Router is responsible for tracking the accessibility of the Classes and Instances via the DeviceNet network. Functionally (transparent to the user), the object routes explicit messages to the various objects in the device. What can be obtained directly from this class is a list of objects that the device supports.

5.2.1. Attributes

Table 5-9 Message Router Instance 0 Attributes

Attrib ID	Name	Data Type	Access Rule	NV	Description	Notes
1	Revision	UINT	GET	NV	Revision of the Message Router object class definition upon which the implementation is based.	If updates require an increase in this value, then the value of this attribute increases by 1. Range 1– 65535

Table 5-10 Message Router Instance 1 Attributes

Attrib ID	Name	Data Type	Access Rule	NV	Description	Notes
1	Object List	STRUCT of:	Get	NV	A List of supported objects	
	Number	UINT			The number of supported classes in the class array.	
	Classes	ARRAY OF UNIT			A list of Class ID codes	

Brooks DeviceNet MFCs/MFMs

5.2.2. Services

Table 5-11 Message Router Instance 0 Services

Service Code	Service Name	Service Description	Details
0x0E	Get Attribute Single	Returns the contents of the specified attribute	Appendix E: Get Attribute Single

Table 5-12 Message Router Instance 1 Services

Service Code	Service Name	Service Description	Details
0x0E	Get Attribute Single	Returns the contents of the specified attribute	Appendix E: Get Attribute Single

5.2.3. Service Details

NONE

5.3. DeviceNet Object [0x3]

The DeviceNet Object is responsible for maintaining and managing the DeviceNet communications interface for the device. Information concerning the MAC ID and Baud Rate of the device can be found here.

This object also is responsible for managing the pre-defined Master/Slave Connection Set. Through this object, services are provided to allocate and release connections associated with the connection set.

5.3.1. Rules Governing Master/Slave Connections

- When allocating Master/Slave connections using the Allocate service, the entire allocation request must be valid or else the allocation is rejected.
- When allocating any of the Master/Slave I/O Connections, the Explicit Connection must have already been allocated first. Or, if the Explicit Connection has not been allocated, it can be allocated in the same request as the I/O Connections.
- A Master/Slave Connection that is already allocated cannot be allocated again unless it is first released. The allocation of a Connection that has already been allocated AND not released will be considered an invalid request.
- Multiple Master/Slave Connections can be requested in the same allocation request.
- Once a Master has made a successful allocation request to a slave, no other Master may make allocation requests to the slave until all Master/Slave connections are released.
- Any Master may release Master/Slave connections in any Slave.

Brooks DeviceNet MFCs/MFMs

5.3.2. Attributes

Table 5-13 DeviceNet Object Instance 0 Attributes

Attrib ID	Name	Data Type	Access Rule	NV	Description	Notes
1	Revision	UINT	Get	NV	Revision of the DeviceNet object class definition upon which the implementation is based.	If updates require an increase in this value, then the value of this attribute increases by 1. Range 1– 65535

Table 5-14 DeviceNet Object Instance 1 Attributes

Attrib ID	Name	Data Type	Access Rule	NV	Description	Notes
1	MAC ID	USINT	Cond.	NV	The node address of this device	See 'Note: MAC ID' below
2	Baud Rate	USINT	Cond.	NV	The communication data rate	See 'Note: Baud Rate' below
3	BOI	BOOL	Set	V	Bus Off Interrupt	See 'Note: BOI' below
4	Bus Off Counter	USINT	Set	V	Number of times CAN went to the Bus-Off-State	Range 0-255
5	Allocation Information	STRUCT of:	Get	V		
	Allocation Choice Byte	BYTE			The current Master/Slave Connection set Connections that have been allocated	See 'Note: Allocation Information' below
	Master's MAC ID	USINT			The node address of the current Master	
6	MAC ID Switch Changed	BOOL	Get	V	The Node Address Switch(es) have changed since last power-up/reset	See 'Note: MAC ID Switch changed'
7	Baud Rate Switch Changed	BOOL	Get	V	The Baud Rate Switch has changed since the last power-up/reset	See 'Note: Baud Rate Switch changed'
8	ID Switch Value	USINT	Get	V	Actual value of the Node Address switches	
9	Baud Rate Switch Value	USINT	Get	V	Actual value of the Baud Rate switch	

5.3.2.1. Note: MAC ID

The valid range of values for this attribute is 0 to 63. Setting the MAC ID switches on top of the device can configure the node address of this device. Reading this attribute will return the node address as configured by the switches. However, if switch “MSD” is placed in the range labeled “P”, the node address must be configured by setting this attribute using the Set Attribute Single service. In either case, once the MAC ID has been configured, the value is retained in non-volatile memory, and the device must be power cycled, or a Reset service must be sent to the Identity Object for the changes to take affect. If the device cannot determine what its MAC ID should be, the MAC ID defaults to 63.

NOTE:

If the “MSD” switch is not in the range labeled “P”, the Set Attribute Single service will return the error code 0x0E (“Attribute not settable”).

5.3.2.2. Note: Baud Rate

The valid values for this attribute are:

Table 5-15 Baud Rate Values

Value	Meaning
0	125
1	250
2	500

Setting the Baud Rate switch on top of the device can configure the communication’s data rate of this device. Reading this attribute will return the node address as configured by the switches. However, if the Baud Rate switch is placed in the range labeled “P”, the data rate must be configured by setting this attribute using the Set Attribute Single service. In either case, once the Baud Rate has been configured, the value is retained in non-volatile memory, and the device must be power cycled, or a Reset service must be sent to the Identity Object for the changes to take affect. If the device cannot determine what its Baud Rate should be, the device defaults to 500K.

NOTE:

If the Baud Rate switch is not in the range labeled “P”, the Set Attribute Single service will return the error code 0x0E (“Attribute not settable”).

Brooks DeviceNet MFCs/MFMs

5.3.2.3. Note: MAC ID Switch Changed

If either of the MAC ID switch positions have changed and the device has not been subsequently power cycled this attribute will be set to true. Once the device has been power cycled this attribute will return to a value of false.

5.3.2.4. Note: Baud Rate Switch Changed

If the Baud Rate switch has been changed and the device has not been subsequently power cycled this attribute will be set to true. Once the device has been power cycled this attribute will return to a value of false.

5.3.2.5. Note: BOI

This attribute configures the action that the device will take in processing the Bus Off Interrupt. Valid values are:

Table 5-16 BOI Values

Value	Meaning
0	Hold the CAN chip in its bus-off (reset) state upon detection of a bus-off indication.
1	Upon detection of a bus-off condition, if possible, fully reset the CAN chip and continue communicating.

5.3.2.6. Note: Allocation Information

Part of the information contained in this attribute indicates the Master/Slave Connections that are currently allocated and active. The table below details the bit mapping of this BYTE descriptor.

Table 5-17 Allocation Information

Bit	7	6	5	4	3	2	1	0
Description	0	0	0	0	0	0	Polled	Explicit Message

5.3.3. Services

Table 5-18 DeviceNet Object Instance 0 Services

Service Code	Service Name	Service Description	Details
0x0E	Get Attribute Single	Returns the contents of the specified attribute	Appendix E: Get Attribute Single

Table 5-19 DeviceNet Object Instance 1 Services

Service Code	Service Name	Service Description Details	Details
0x0E	Get Attribute Single	Returns the contents of the specified attribute	Appendix E: Get Attribute Single
0x10	Set Attribute Single	Sets the contents of the specified attribute	Appendix E: Set Attribute Single
0x4B	Allocate Master/Slave Connection	Requests the instantiation of a Master/Slave Connection	Allocate Master/Slave Connection
0x4C	Release Master/Slave Connection	Releases (deletes) a Master/Slave Connection	Release Master/Slave Connection

5.3.4. Service Details

5.3.4.1. Allocate Master/Slave Connection

Table 5-20 Allocate Service Arguments

Parameter Name	Data Type	Required	Parameter Value	Semantics
Allocation Choice Byte	BYTE	Y	See Allocation Choice Byte Values Below	Selects the Master/Slave connection to be allocated (opened) in the slave device.
Allocator's MAC ID	USINT	Y	0 to 63	The MAC ID of the Master Device issuing this request

Brooks DeviceNet MFCs/MFMs

Table 5-21 Allocation Choice Byte Values

Bit	7	6	5	4	3	2	1	0
Description	0	0	0	0	0	0	Polled	Explicit Message

Table 5-22 Allocate Service Response

Parameter Name	Data Type	Required Value	Parameter	Semantics
Message Body Format	BYTE	Y		Sets the format of the Explicit Message body to be used between the Client (Master) and the slave device. This value can be ignored by the Client

5.3.4.2. Release Master/Slave Connection

Table 5-23 Release Service Arguments

Parameter Name	Data Type	Required	Parameter Value	Semantics
Release Choice Byte	BYTE	Y	See Release Choice Byte Value Below	Selects the Master/Slave connection to release (close) in the slave device.

Table 5-24 Release Choice Byte Value

Bit	7	6	5	4	3	2	1	0
Description	0	0	0	0	0	0	Polled	Explicit Message

Table 5-25 Release Service Response

Parameter Name	Data Type	Required	Parameter Value	Description
NO RESPONSE DATA				

5.4. Assembly Object [0x4]

The Assembly Object contains a list of attributes that data can be written to (sink) and read from (source) via the Data Buffer attribute contained in this object. The Assembly Object is generally assigned as the endpoint of an I/O Connection object (assigned via the Path attributes in the Connection Object). In this way, multiple pieces of data can be moved to and from the device with a reduced number of network messages.

Table 5-26 Assembly Object Instance 0 Attributes

Attrib ID	Name	Data Type	Access Rule	NV	Description	Notes
1	Revision	UINT	Get	NV	Revision of the Assembly object class definition upon which the implementation is based.	If updates require an increase in this value, then the value of this attribute increases by 1. Range 1– 65535

Table 5-27 Assembly Object Instance 1..n Attributes

Attrib ID	Name	Data Type	Access Rule	NV	Description	Notes
1	Number of Members in List	UINT	Get	NV	Lists the number of members in this Assembly instance	
2	Member List	ARRAY of STRUCT:	Get	NV	The member list is an array of DeviceNet paths	
	Member Data Description	UINT			Size of member data	Size in bits
	Member Path Size	UINT			Size of member path	Size in bytes
	Member Path	EPATH			Path to the attribute this member points to	
3	Data Buffer	ARRAY of BYTE	Set		The data buffer to sink or source the member(s) data	The size of this attribute can be determined by adding together the Member Data Description for each member in the Assembly

Brooks DeviceNet MFCs/MFMs

5.4.1. Services

Table 5-28 Assembly Object Instance 0 Services

Service Code	Service Name	Service Description	Details
0x0E	Get Attribute Single	Returns the contents of the specified attribute	Appendix E: Get Attribute Single

Table 5-29 Assembly Object Instance 1..n Services

Service Code	Service Name	Service Description	Details
0x0E	Get Attribute Single	Returns the contents of the specified attribute	Appendix E: Get Attribute Single
0x10	Set Attribute Single	Sets the contents of the specified attribute with the value passed with this service	Appendix E: Set Attribute Single

5.4.2. Service Details

NONE

5.5. Connection Object [0x5]

5.5.1. Rules Governing Master/Slave Connections [0x5]

The Connection Object configures the characteristics and behavior of a logical connection in the device. A Connection is allocated (opened) in the device by the Master via the Allocate M/S Connection Request service in the DeviceNet Object. Configuration of the Connection Object attributes for the requested connection is done automatically in the device and generally need no further modification except for setting the Expected Packet Rate attribute (Attribute 9). However, it is within this object that selection of Input/Output assemblies may be configured. This configuration can be performed the following ways:

- Modification of Attribute 100 and 101 in the M/S Explicit Connection
- Modification of the Produce and Consume Path attributes (Attribute 14 and 15 respectively) in the I/O Connection Objects

OR

- Via the diagnostic port using the Brooks Service Suite

5.5.2. Attributes

Table 5-30 Connection Object Instance 0 Attributes

Attrib ID	Name	Data Type	Access Rule	NV	Description	Notes
1	Revision	UINT	Get	NV	Revision of the Connection object class definition upon which the implementation is based.	If updates require an increase in this value, then the value of this attribute increases by 1. Range 1– 65535

Brooks DeviceNet MFCs/MFMs

5.5.2.1. Explicit Connection Attributes

Table 5-31 Instance 1 - M/S Explicit Connection Attributes

Attrib ID	Name	Data Type	Access Rule	Description	Notes
1	State	USINT	Get	State of Object	Note: 'State' below Default: 3 = Established State
2	Instance Type	USINT	Get	Indicates type of Connection	Default: 0 = Explicit Connection
3	Transport Class & Trigger	USINT	Set ¹	Defines behavior of Connection Placed in CAN Identifier	Note: 'Transport Class & Trigger' below Default: 0x83
4	Produced Connection ID	UINT	Get	Placed in CAN Identifier Field when the Connection transmits	
5	Consume Connection ID	UINT	Get	CAN Identifier Field value that denotes message to be received	
6	Initial Comm Characteristics	BYTE	Get	Defines the Message Group(s) across which productions and consumptions associated with this Connection occur	Note: 'Initial Comm Characteristics' below Default: 0x21
7	Produced Connection Size	UINT	Set ¹	Maximum number of bytes transmitted across this Connection	Default: 0x017C
8	Consumed Connection Size	UINT	Get	Maximum number of bytes received across this Connection	Default: 0x017C
9	Expected Packet Rate (EPR)	UINT	Set	Defines timing associated with this Connection in milliseconds	Default: 2500 msec
12	Watchdog Timeout Action	USINT	Set	Specifies how the Connection will handle inactivity/watchdog timeouts	Note: 'Watchdog Timeout Action' below Default: 1 = Auto Delete
13	Produce Connection Path Length	UINT	Get	Number of bytes in the Produced Connection Path attribute	Default: 0
14	Produce Connection Path	EPATH	Set ¹	Specifies the application object data to be produced by this Connection	Default: Empty
15	Consume Connection Path Length	UINT	Get	Number of bytes in the Consume Connection Path attribute	Default: 0

¹ Settable while the connection is in the Configuring State.

Table 5-31 Instance 1 - M/S Explicit Connection Attributes (continued)

Attrib ID	Name	Data Type	Access Rule	Description	Notes
16	Consume Connection Path	EPATH	Set ¹	Specifies the application object to receive data by this Connection	Default: Empty
100	Default Polled I/O Conn. Produce Assembly Instance	UINT	Set	Specifies the default Assembly Object instance to be set in the Produce Connection Path when the M/S Polled I/O Connection Object is instantiated	The value of this attribute is stored in Non-Volatile memory.
101	Default Polled I/O Conn. Consume Assembly Instance	UINT	Set	Specifies the default Assembly Object instance to be set in the Consume Connection Path when the M/S Polled I/O Connection Object is instantiated	The value of this attribute is stored in Non-Volatile memory.

5.5.2.2. Poll I/O Connection Attributes

Table 5-32 Instance 2 - M/S Polled I/O Connection Attributes

Attrib ID	Name	Data Type	Access Rule	Description	Notes
1	State	USINT	Get	State of Object	Note: 'State' below Default: 1 = Configuring State
2	Instance Type	USINT	Get	Indicates type of Connection	Default: 1 = I/O Connection
3	Transport Class & Trigger	USINT	Set ¹	Defines behavior of Connection	Note: 'Transport Class & Trigger' below Default: 0x82
4	Produced Connection ID	UINT	Get	Placed in CAN Identifier Field when the Connection transmits	

¹ Settable while the connection is in the Configuring State.

Brooks DeviceNet MFCs/MFMs

Table 5-32 Instance 2 - M/S Polled I/O Connection Attributes (continued)

Attrib ID	Name	Data Type	Access Rule	Description	Notes
5	Consume Connection ID	UINT	Get	CAN Identifier Field value that denotes message to be received	
6	Initial Comm Characteristics	BYTE	Get	Defines the Message Group(s) across which productions and consumptions associated with this Connection occur	Note: 'Initial Comm Characteristics' below Default: 0x01
7	Produced Connection Size	UINT	Set ¹	Maximum number of bytes transmitted across this Connection	Defined by the size of the Application Data object pointed to by Produce Connection Path attribute
8	Consumed Connection Size	UINT	Get	Maximum number of bytes received across this Connection	Defined by the size of the Application Data object pointed to by Produce Connection Path attribute
9	Expected Packet Rate (EPR)	UINT	Set	Defines timing associated with this Connection	Must be configured. Once this value is set, the Polled I/O Connection transitions to the Established State
12	Watchdog Timeout Action	USINT	Set	Specifies how the Connection will handle inactivity/watchdog timeouts	Note: 'Watchdog Timeout Action' below Default: 0 = Timed Out Stat
13	Produce Connection Path Length	UINT	Get	Number of bytes in the Produced Connection Path attribute	Default: 6
14	Produce Connection Path	EPATH	Set ¹	Specifies the application object data to be produced by this Connection	This attribute is settable only in the Configuring State Default: As defined by Attribute 100 in the M/S Explicit Connection instance.
15	Consume Connection Path Length	UINT	Get	Number of bytes in the Consume Connection Path attribute	Default: 6
16	Consume Connection Path	EPATH	Set ¹	Specifies the application object to receive data by this Connection	This attribute is settable only in the Configuring State Default: As defined by Attribute 101 in the M/S Explicit Connection instance.

¹ Settable while the connection is in the Configuring State.

5.5.2.3. Note: State

Table 5-33 Rules Governing Master/Slave Connections [0x5]

Value	State	Description
0	Non-Existent	The Connection has not yet been instantiated
1	Configuring	The Connection has been instantiated, but not properly configured. Upon completion of configuration the Apply service must be sent to the Connection
2	Waiting for Connection ID	The Connection is waiting exclusively for the Produce or Consume Connection ID's to be set
3	Established	The Connection has been properly configured and applied
4	Timed Out	The Inactivity/Watchdog has timed out and may have transitioned to this state if the Watchdog Timeout Action attribute has been configured to do so. See Attribute 12.
5	Deferred Delete	If the Connection Object is of Explicit Message Connection type (see Attribute 2) and the Inactivity/Watchdog has timed out, the Connection may transition to this state if the Watchdog Timeout Action attribute has been configured to do so. See Attribute 12.

5.5.2.4. Note: Transport Class & Trigger

Table 5-34 Bit Descriptions

Bit	7	6	5	4	3	2	1	0
Description	Direction	Production Trigger				Transport Class		

Table 5-35 Direction

Value	Description
0	Client
1	Server

Table 5-36 Production Trigger

Value	Description
2	Application Object

Brooks DeviceNet MFCs/MFMs

Table 5-37 Transport Class

Value	Description
0	Class 0
1	Reserved
2	Class 2
3	Class 3

5.5.2.5. Note: Initial Comm. Characteristics

Table 5-38 Bit Descriptions

Bit	7	6	5	4	3	2	1	0
Description	Initial Production Characteristics				Initial Consume Characteristics			

Table 5-39 Initial Production Characteristics

Value	Description
0	Produce Across Message Group 1
1	Produce Across Message Group 2 (Destination)
2	Produce Across Message Group 2 (Source)
3	Produce Across Message Group 3

Table 5-40 Initial Consume Characteristics

Value	Description
0	Consume A cross Message Group 1
1	Consume Across Message Group 2 (Destination)
2	Consume Across Message Group 2 (Source)
3	Consume Across Message Group 3

5.5.2.6. Note: Watchdog Timeout Action

Table 5-41 Watchdog Timeout Action

Value	Timeout Action	Description
0	Transition to Timed Out	The Connection transitions to the Timed Out state and remains in that state until Deleted or Reset. Invalid value for Explicit Connections
1	Auto Delete	The Connection Class automatically deletes the Connection if an Inactivity/Watchdog timeout occurs
2	Auto Reset	The Connection remains in the Established State and restarts the Inactivity/Watchdog timer
3	Deferred Delete	The Connection transitions to the Deferred Delete state if any child connection instances are in the Established state. If no child connection instances are in the Established state the connection is deleted. This value is invalid for I/O Messaging Connections.

5.5.3. Services

Table 5-42 Connection Object Instance 0 Services

Service Code	Service Name	Service Description	Details
NO INSTANCE 0 SERVICES ARE SUPPORTED			

Table 5-43 Connection Object Instance 1 Services

Service Code	Service Name	Service Description	Details
0x0E	Get Attribute Single	Returns the contents of the specified attribute	Appendix E: Get Attribute Single
0x10	Set Attribute Single	Sets the contents of the specified attribute with the value passed with this service	Appendix E: Set Attribute Single
0x5	Reset	Used to reset the Inactivity/Watchdog timer and transition the Connection back to the Established state.	No Arguments or Response Data

Brooks DeviceNet MFCs/MFMs

5.5.4. Service Details

NONE

5.6. S-Device Supervisor Object [0x30]

The S-Device Supervisor Object oversees device operation and status. This object maintains an internal state machine that is used to govern the behavior of the Sensor, Actuator, and Controller objects. Also contained in this object are informational attributes extending to those provided in the Identity Object.

5.6.1. Attributes

Table 5-44 S-Device Supervisor Instance 0 Attributes

Attrib ID	Name	Data Type	Access Rule	NV	Description	Notes
1	Revision	UINT	Get	NV	Revision of the S-Device Supervisor object class definition upon which the implementation is based.	The current revision of this object is 02, as defined by ODVA.

Table 5-45 S-Device Supervisor Instance 1 Attributes

Attrib ID	Name	Data Type	Access Rule	NV	Description	Notes
3	Device Type	SHORT STRING	Get	NV	SEMI Standard specified name which identifies the Device Model within the <i>Hierarchy of Semiconductor Equipment Devices</i>	Max. 8 Characters 'MFC' or 'MFM'
4	SEMI Standard Revision Level	SHORT STRING	Get	NV	Specifies the revision level of the SEMI S/A Network Standard to which this device complies	'E54-0997'
5	Manufacturer's Name	SHORT STRING	Get	NV	The name of the manufacturer of the device.	Max. 20 characters 'Brooks Instrument'
6	Manufacturer's Model Number	SHORT STRING	Get	NV	The manufacturer specified model number for the device	Max. 20 characters

Table 5-45 S-Device Supervisor Instance 1 Attributes (continued)

Attrib ID	Name	Data Type	Access Rule	NV	Description	Notes
7	Software Revision Level	SHORT STRING	Get	NV	Revision level of the firmware in the device.	Note: 'Software Revision Level' below
8	Hardware Revision Level	SHORT STRING	Get	NV	Revision level of the hardware in the device.	
9	Manufacturer's Serial Number	SHORT STRING	Get	NV	Serial number of device assigned by the manufacturer	Max. 30 Characters
10	Device Configuration	SHORT STRING	Get	NV	Any additional manufacturer specific information about the device	Max. 50 characters 'N/A'
11	Device Status	USINT	Get	V	The current operational state of the device.	Note: 'Device Status' below
12	Exception Status	BYTE	Get	V	Summary status of the current warning and alarm status in the device	Note: 'Exception Status' below

Brooks DeviceNet MFCs/MFMs

Table 5-45 S-Device Supervisor Instance 1 Attributes (continued)

Attrib ID	Name	Data Type	Access Rule	NV	Description	Notes
13	Exception Detail Alarm	STRUCT of:	Get	V	A complex structure made up of 3 levels of alarm exception details.	
	Common Exception Detail	STRUCT of:			Common detail bytes defined by the Supervisor Object	See "Note: Exception Detail Alarm – Common Exception Detail" below
	Size	USINT				
	Detail	ARRAY of:				
	Detail n	BYTE				
	Device Exception Detail	STRUCT of:			Device detail bytes defined for MFC/MFM device types.	See "Note: Exception Detail Warning – Device Exception Detail" below
	Size	USINT				
	Detail	ARRAY of:				
	Detail n	BYTE				
	Manufacturer Exception Detail	STRUCT of:			Manufacturer detail bytes as defined by Brooks Instrument	See "Note: Exception Detail Alarm – Manufacturer Exception Detail" below
	Size	USINT				
	Detail	ARRAY of:				
	Detail n	BYTE				

Table 5-45 S-Device Supervisor Instance 1 Attributes (continued)

Attrib ID	Name	Data Type	Access Rule	NV	Description	Notes
14	Exception Detail Warning	STRUCT of:	Get	V	A complex structure made up of 3 levels of alarm exception details.	
	Common Exception Detail	STRUCT of:			Common detail bytes defined by the Supervisor Object	See "Note: Exception Detail Warning – Common Exception Detail" below
	Size	USINT				
	Detail	ARRAY of:				
	Detail n	BYTE				
	Device Exception Detail	STRUCT of:			Device detail bytes defined for MFC/MFM device types.	See "Note: Exception Detail Warning – Device Exception Detail" below
	Size	USINT				
	Detail	ARRAY of:				
	Detail n	BYTE				
	Manufacturer Exception Detail	STRUCT of:			Manufacturer detail bytes as defined by Brooks Instrument	See "Note: Exception Detail Warning – Manufacturer Exception Detail" below
	Size	USINT				
	Detail	ARRAY of:				
	Detail n	BYTE				

Brooks DeviceNet MFCs/MFMs

Table 5-45 S-Device Supervisor Instance 1 Attributes (continued)

Attrib ID	Name	Data Type	Access Rule	NV	Description	Notes
15	Alarm Enable	BOOL	Set	NV	Enables/Disables the Supervisor Object's processing of Alarm information	
16	Warning Enable	BOOL	Set	NV	Enables/Disables the Supervisor Object's processing of Warning information	
99	Subclass	UINT	Get	NV	Identifies a subset of additional instance attributes, services, and behaviors for the Supervisor Object	There are no additional Attributes or Services defined for this implementation

5.6.1.1. Note: Software Revision Level

This attribute represents the current firmware revision running in the device. Brooks Instrument defines the format of this revision level. The format of this attribute is comprised of the major and minor revision level, separated by a decimal point (for example, 1.04).

5.6.1.2. Note: Device Status

The value of this attribute represents the current operational state of the device. The values are defined in the following table. A State Event Matrix and State Event Diagram are outlines in Appendix F - State Machine.

Table 5-46 Device Status

Attrib	Operational	Safe	Description
0	Undefined	Y	
1	Self Testing	Y	All object instances exist and have been initialized. Exception Status bits have been reset. The device is executing internal tests to determine if the device is qualified to begin normal monitoring and control operations.
2	Idle	Y	The device is ready for normal monitoring and control operations.
3	Self Test Exception	Y	The device has detected an exceptional condition during self-test. The details of the exception are stored in the exception detail attributes of the Supervisor Object.
4	Executing	N	The device is performing normal control and monitoring operations
5	Abort	Y	The device is idle, but is NOT ready for normal monitoring and control operations. A Recover Request must be initiated to reach a ready condition.
6	Critical Fault	Y	The Supervisor Object and device are in a fault state from which there is no recovery.

5.6.1.3. Note: Exception Status

Exception Status for this device utilizes the Expanded Method outlined in the ODVA specification for the S-Device Supervisor Object. This is indicated by setting bit 7 in this attribute to 1.

The table below shows the format of bits in this attribute. The setting of any of these bits is obtained by taking the logical "OR" of the related exception detail bits. For example, if any of the bits in the Device Common Alarm Detail are set, bit 0 of this attribute will be set to 1.

Brooks DeviceNet MFCs/MFMs

Table 5-47 Exception Status

Bit 7	Bit 6	Bit 5	Bit 4	Bit 3	Bit 2	Bit 1	Bit 0
1	Warning Mfr. Specific	Warning Device Specific	Warning Device Common	0	Alarm Mfr. Specific	Alarm Device Specific	Alarm Device Common
	See "Note: Exception Detail Warning – Manufacturer Exception Detail"	See "Note: Exception Detail Warning – Device Exception Detail"	See "Note: Exception Detail Warning – Common Exception Detail"		See "Note: Exception Detail Alarm – Manufacturer Exception Detail"	See "Note: Exception Detail Alarm – Device Exception Detail"	See "Note: Exception Detail Alarm – Common Exception Detail"

5.6.1.4. Note: Exception Detail Alarm – Common Exception Detail

Table 5-48 Alarm – Common Exception Detail

	Bit 7	Bit 6	Bit 5	Bit 4	Bit 3	Bit 2	Bit 1	Bit 0
Detail Size	2							
Detail Byte 0	0	0	0	RAM	NV RAM	Flash Memory	0	Diagnostic
Detail Byte 1	0	0	0	0	0	0	0	0

5.6.1.5. Note: Exception Detail Alarm – Device Exception Detail

Table 5-49 Alarm – Device Exception Detail

	Bit 7	Bit 6	Bit 5	Bit 4	Bit 3	Bit 2	Bit 1	Bit 0
Detail Size	1							
Detail Byte 0	0	0	Valve High	Valve Low	Flow Control	Flow High	Flow Low	0

5.6.1.6. Note: Exception Detail Alarm – Manufacturer Exception Detail

Table 5-50 Alarm – Manufacturer Exception Detail

	Bit 7	Bit 6	Bit 5	Bit 4	Bit 3	Bit 2	Bit 1	Bit 0
Detail Size	0 (None Defined)							

5.6.1.7. Note: Exception Detail Warning – Common Exception Detail

Table 5-51 Warning – Common Exception Detail

	Bit 7	Bit 6	Bit 5	Bit 4	Bit 3	Bit 2	Bit 1	Bit 0
Detail Size	2							
Detail Byte 0	0	0	0	0	0	0	0	Diagnostic
Detail Byte 1	0	0	0	0	0	0	0	0

5.6.1.8. Note: Exception Detail Warning – Device Exception Detail

Table 5-52 Warning – Device Exception Detail

	Bit 7	Bit 6	Bit 5	Bit 4	Bit 3	Bit 2	Bit 1	Bit 0
Detail Size	1							
Detail Byte 0	0	0	Valve High	Valve Low	Flow Control	Flow High	Flow Low	Not Reading Valid for Flow

5.6.1.9. Note: Exception Detail Warning – Manufacturer Exception Detail

Table 5-53 Warning – Manufacturer Exception Detail

	Bit 7	Bit 6	Bit 5	Bit 4	Bit 3	Bit 2	Bit 1	Bit 0
Detail Size	0 (None Defined)							

5.6.2. Services

Table 5-54 S-Device Supervisor Instance 0 Services

Service Code	Service Name	Service Description	Details
0x0E	Get Attribute Single	Returns the contents of the specified attribute	Appendix E: Get Attribute Single

Brooks DeviceNet MFCs/MFMs

Table 5-55 S-Device Supervisor Instance 1 Services

Service Code	Service Name	Service Description	Details
0x0E	Get Attribute Single	Returns the contents of the specified attribute	Appendix E: Get Attribute Single
0x10	Set Attribute Single	Sets the contents of the specified attribute with the value passed with this service	Appendix E: Set Attribute Single
0x05	Reset	Resets the device to the Self-Testing state	Acceptance of these services is dependent upon the current device operational state. See State Event Matrix or Diagram in Appendix F - State Machine. For details on performing the Diagnostic Service go to Perform Diagnostics in Service Details section
0x06	Start	Moves the device to the Executing State	
0x07	Stop	Moves the device to the Idle State	
0x4B	Abort	Moves the device to the Abort State	
0x4C	Recover	Moves the device out of the Abort State	
0x4E	Perform Diagnostics	Causes the device to perform a set of diagnostic routines.	

5.6.2.1. Service Details

5.6.2.1.1. Perform Diagnostics

Table 5-56 Diagnostics Service Arguments

Parameter Name	Data Type	Required	Parameter Value	Semantics
Test ID	USINT	N	See Test ID Table Below	The identifier of the diagnostic test to be performed. See Table Below

Table 5-57 Test ID

Test ID	Description
0 (default)	Standard

Table 5-58 Diagnostic Service Response

Parameter Name	Data Type	Required Value	Parameter	Description
NO RESPONSE DATA				

5.7. S-Analog Sensor Object [0x31]

The S-Analog Sensor Object is responsible for reporting sensor values. The sensor object in conjunction with the selected S-Gas Calibration Object can linearize the sensor values and convert measurements into engineering data units.

5.7.1. Attributes

Table 5-59 S-Analog Sensor Instance 0 Attributes

Attrib ID	Name	Data Type	Access Rule	NV	Description	Notes
1	Revision	UINT	Get	NV	Revision of the S-Analog Sensor object class definition upon which the implementation is based.	If updates require an increase in this value, then the value of this attribute increases by 1. Range 1– 65535

Table 5-60 S-Analog Sensor Instance 1 Attributes

Attrib ID	Name	Data Type	Access Rule	NV	Description	Notes
3	Data Type	USINT	Cond.	NV	Defines the Data Type of Flow[6] and other attributes in this object.	See Note 'Data Type' below Default = INT
4	Data Units	ENGUNITS	Cond.	NV	Defines the Engineering Units context of Flow[6] and other attributes in this object.	See Note 'Data Units' below Default = Counts
5	Reading Valid	BOOL	Get	V	Indicates that Flow[6] has a valid value.	0 = Invalid Sensor Value 1 = Valid Sensor Value
6	Flow	Specified by Attrib. 3 & 4	Get	V	The amount of flow going through the sensor	This value is corrected, converted, and calibrated to report the actual value of flow.
7	Status	BYTE	Get	V	Alarm and Warning status for the S-Analog Sensor Object	See Note 'Status' below
8	Alarm Enable	BOOL	Set	NV	Enables the setting of the alarm status bits	See Note: Alarms below 0 = disable [default] 1 = enable

Brooks DeviceNet MFCs/MFMs

Table 5-60 S-Analog Sensor Instance 1 Attributes (continued)

Attrib ID	Name	Data Type	Access Rule	NV	Description	Notes
9	Warning Enable	BOOL	Set	NV	Enables the display of the warning status bits	See Note: Warnings below 0 = disable [default] 1 = enable
10	Full Scale	Specified by Attrib. 3 & 4	Get	NV	The flow value that represents 100% of the currently selected calibration full scale	See Note 'Full Scale' below
17	Alarm Trip Point High	Specified by Attrib. 3 & 4	Set	NV	Determines the Flow[6] value above which an Alarm Condition will occur	See 'Note: Alarms' below [default] = Maximum value for its data type
18	Alarm Trip Point Low	Specified by Attrib. 3 & 4	Set	NV	Determines the Flow[6] value below which an Alarm Condition Will occur	See 'Note: Alarms' below [default] = Minimum value for its data type
20	Alarm Settling Time	UINT	Set	NV	Determines the time that the Flow[6] value must exceed the Trip Point before the exception condition is generated.	See 'Note: Alarms' below Time in milliseconds 0 = [default]
21	Warning Trip Point High	Specified by Attrib. 3 & 4	Set	NV	Determines the Flow[6] value above which a Warning Condition will occur	See 'Note: Warnings' below [default] = Maximum value for its data type
22	Warning Trip Point Low	Specified by Attrib. 3 & 4	Set	NV	Determines the Flow[6] value below which a Warning Condition will occur	See 'Note: Warnings' below [default] = Minimum value for its data type
24	Warning Settling Time	UINT	Set	NV	Determines the time that the Flow[6] value must exceed the Trip Point before the exception condition is generated.	See 'Note: Warnings' below Time in milliseconds 0 = [default]

Table 5-60 S-Analog Sensor Instance 1 Attributes (continued)

Attrib ID	Name	Data Type	Access Rule	NV	Description	Notes
25	Safe State	USINT	Set	NV	Specifies the behavior of value reported for Flow[6] when the device is in an Operational State other than Executing State	See Note 'Safe State' below
26	Safe Value	Specified by Attrib. 3 & 4	Set	NV	The value that is indicated by Flow[6] if the Safe State[25] is configured to "Use Safe Value"	
28	Auto-zero Status	BOOL	Get	V	Indicates the status of the automatic nulling	0 = [default]
35	Gas Calibration Object Instance	UINT	Set	NV	Configures which S-Gas Calibration Object instance is currently active for this object.	See Note 'Gas Calibration Object Instance' below
95	Flow Totalizer	ULINT	Set	NV	Total gas flowed through the device since this value was set to 0.	Units are SCCM. See Note "Flow Totalizer and Flow Hours Process" below. Default = 0.
96	Flow Hours	UDINT	Set	NV	Total time device has been powered and flowing gas since this value was last set to 0.	Resolution is 1 hour. See Note "Flow Totalizer and Flow Hours Process" below. Default = 0.
99	Subclass	UINT	Get	NV	Identifies a subset of additional instance attributes, services, and behaviors for the Sensor Object	The value of this attribute is 1 = Flow Diagnostics Subclass

Brooks DeviceNet MFCs/MFMs

5.7.1.1. Note: Data Type

The value of this attribute is limited to INT or REAL. This attribute can only be set when the device is not in the Operational State of Executing. If any of the attributes in this object use the attribute Data Type[3] to define their data type and the attribute is the end point of an active I/O connection, then the access rule for the attribute Data Type[3] becomes Get and thus cannot be set until the I/O connection becomes inactive. Additionally, the inferred data type of an Assembly object (see The “Inferred” Data Type) will modify this value if the Assembly object has been assigned to an active I/O connection.

Example 1: If the value of Flow[6] is exchanged via the Polled I/O connection, Data Type[3] cannot be modified until that Polled I/O Connection is terminated.

Example 2: If Assembly instance 1 is assigned to the Polled I/O connection produce path, the value of Data Type[3] will be set to INT when the Polled I/O connection transitions to the Active state. When the Polled I/O connection is terminated, the value of this attribute will remain INT. It will not return to the value prior to commissioning the Polled I/O connection.

5.7.1.2. Note: Data Units

The value of this attribute is limited to the values specified in the Volumetric Flow Units Table and Mass Flow Units table in Appendix C - Data Units. This attribute can only be set when the device is not in the Operational State of Executing. See Example 1 above in Note: Data Type.

5.7.1.3. Note: Status

The following table defines the bits in this status byte. The value of 1 = Set and 0 = Cleared.

Table 5-61 Status

Bit 7	Bit 6	Bit 5	Bit 4	Bit 3	Bit 2	Bit 1	Bit 0
0	0	0	0	Low Flow Warning	High Flow Warning	Low Flow Alarm	High Flow Alarm

5.7.1.4. Note: Full Scale

The value of this attribute will depend upon the values configured for attributes 4 and 35. The following table will describe the behavior of this attribute.

Table 5-62 Full Scale

Data Units	Full Scale Definition
Counts	Default = 24576 for Full Scale[10] regardless of the selected calibration object full scale. This allows for an overshoot indication of 133% of the calibrated full scale (e.g. 32767 = 133%). To change this, utilize the Set Full Scale Counts service to set the desired 100% full scale. A good formula to use is: Full Scale Counts = (100% / Desired Percent Overshoot) X 32767
Percent	The value will always be 100.
Any Volumetric or Mass Flow Engineering Unit	Full Scale[10] will be determined by using the attribute Calibration Full Scale [0x34,1,6] of the S-Gas Calibration Object as configured by the Selected Gas Calibration Object Instance[35] and converted to the configured Data Unit[4]. Example: If Instance 1 of an S-Gas Calibration Object has a Calibration Full Scale[6] of 100 Liters/ sec, and the desired Data Units[4] in the Sensor Object is SCCM, the value of Full Scale[10] will be 600000 (Note: Mass units will take into account the density when doing the conversion).

5.7.1.5. Note: Safe State

The following table outlines valid values for this attribute:

Table 5-63 Safe State

Value	State	Description
0	Zero (default)	The value of Flow[6] will be 0
1	Full Scale	The value of Flow[6] will equal Full Scale[10]
2	Hold Last Value	The value of Flow[6] will hold to the most recent sensor reading just prior to entering the safe state
3	Use Safe Value	The value of Flow[6] will equal Safe Value[26]
4	Continue Sensing	The value of Flow[6] will continue to update normally as if in the Executing State
100	Track	The value of Flow[6] will continue to update normally as if in the Executing State

Brooks DeviceNet MFCs/MFMs

5.7.1.6. Note: Gas Calibration Object Instance

The value of this attribute is limited to the number of S-Gas Calibration Object instances configured in the device. The minimum value is 1, which is also the default value.

5.7.1.7. Note: Alarms

Enable the reporting of Alarms for the S-Analog Sensor object via Alarm Enable[8] attribute. When Flow[6] exceeds the limits set by Alarm Trip Point High[17] or Alarm Trip Point Low[18] a corresponding bit from the Status[7] attribute is set, see Status above.

The attribute Alarm Settling Time[20] sets the interval of a timer that masks the reporting of alarms. Once the timer expires if an alarm condition still exists the warning is reported.

If alarms are enabled in the S-Device Supervisor Object the actuator alarms are reported via the Exception Status [12] and corresponding Exception Detail Alarm[13] of the S-Device Supervisor Object.

5.7.1.8. Note: Warnings

Enable the reporting of Warnings for the S-Analog Sensor object via Warning Enable[9] attribute. When

Flow[6] exceeds the limits set by Warning Trip Point High[21] or Warning Trip Point Low[22] a corresponding bit from the Status[7] attribute is set, see Status above.

The attribute Warning Settling Time[24] sets the interval of a timer that masks the reporting of warnings. Once the timer expires if a warning condition still exists the warning is reported.

If warnings are enabled in the S-Device Supervisor Object the actuator warnings are reported via the Exception Status [12] and corresponding Exception Detail Warning[14] of the S-Device Supervisor Object.

5.7.1.9. Flow Totalizer and Flow Hours Process

The factory configured out-of-box values for the Flow Totalizer and Flow Hours attributes are both 0. The attributes are only modifiable with `set_attribute_single` service requests; they are not altered by the `ResetService`, including power-cycle, of either the Identity or the S-Device Supervisor objects.

The Flow Totalizer attribute is incremented, at a rate of once every cubic centimeter of gas flow, by the S-Analog Sensor object instance to reflect the amount of gas that has flowed through the device. Upon reaching its maximum value, the Flow Totalizer value is no longer incremented and remains at its maximum value.

The Flow Hours attribute is incremented, at a rate of once every hour, by the S-Analog Sensor object instance to reflect the amount of time that gas has flowed through the device. This condition is determined by the `Value` attribute being greater than 0.5% of full scale. Upon reaching its maximum value, the Flow Hours value is no longer incremented and remains at its maximum value.

Brooks DeviceNet MFCs/MFMs

5.7.2. Services

Table 5-64 S-Analog Sensor Instance 0 Services

Service Code	Service Name	Service Description	Details
0x0E	Get Attribute Single	Returns the contents of the specified attribute	Appendix E: Get Attribute Single

Table 5-65 S-Analog Sensor Instance 1 Services

Service Code	Service Name	Service Description	Details
0x0E	Get Attribute Single	Returns the contents of the specified attribute	Appendix E: Get Attribute Single
0x10	Set Attribute Single	Sets the contents of the specified attribute with the value passed with this service	Appendix E: Set Attribute Single
0x4B	Zero Adjust	Indicates to the device that the current Flow Sensor value is zero.	
0x32	Set Full Scale Counts	Defines the Counts value that represents 100% of the calibration full scale	This only affects the way the value of Flow [6] is reported in relation to the Full Scale calibration when the Units[4] is set to Counts.

5.7.2.1. Service Details

5.7.2.1.1. Set Full Scale Counts

Table 5-66 Set Full-Scale Counts Service Arguments

Parameter Name	Data Type	Required	Parameter Value	Semantics
Full Scale Counts	INT	Y	-32768 to 32767	The Counts value that defines 100% of the calibration full scale. The value that is passed here in this argument will be reported in attribute Full Scale[10].

Table 5-67 Set Full-Scale Counts Service Response

Parameter Name	Data Type	Required Value	Parameter	Description
NO SUCCESS RESPONSE DATA				

5.8. S-Analog Actuator Object [0x32]

The S-Analog Actuator is responsible for management of the actuator device controlling the process.

5.8.1. Attributes

Table 5-68 S-Analog Actuator Instance 0 Attributes

Attrib ID	Name	Data Type	Access Rule	NV	Description	Notes
1	Revision	UINT	Get	NV	Revision of the S-Analog Actuator object class definition upon which the implementation is based.	If updates require an increase in this value, then the value of this attribute increases by 1. Range 1– 65535

Brooks DeviceNet MFCs/MFMs

Table 5-69 S-Analog Actuator Instance 1 Attributes

Attrib ID	Name	Data Type	Access Rule	NV	Description	Notes
3	Data Type	USINT	Cond.	NV	Defines the Data Type of Value[6] and other attributes in this object.	See Note 'Data Type' below Default = INT
4	Data Units	ENGUNITS	Cond.	NV	Defines the Engineering Units context of Value[6] and other attributes in this object.	See Note 'Data Units' below Default = Counts
5	Override	USINT	Set	V	Specifies a direct override of the physical actuator	See Note 'Override' below
6	Value	Specified by Attrib. 3 & 4	Get	V	The value of the analog output signal used to drive the physical actuator	See Note 'Valve' below
7	Status	BYTE	Get	V	Alarm and Warning status for the S-Analog Actuator Object	See Note 'Status' below
8	Alarm Enable	BOOL	Set	NV	Enables setting of the Alarm bit	See Note 'Alarms' below 0 = disabled [default] 1 = enabled
9	Warning Enable	BOOL	Set	NV	Enables setting of the Warning bit	See Note 'Warnings' below 0 = disabled [default] 1 = enabled
15	Alarm Trip Point High	Specified by Attrib. 3 & 4	Set	NV	Determines the Value[6] above which an Alarm condition will occur.	See Note 'Alarms' below [default] = Maximum value for its data type
16	Alarm Trip Point Low	Specified by Attrib. 3 & 4	Set	NV	Determines the Value[6] below which an Alarm condition will occur.	See Note 'Alarms' below [default] = Minimum value for its data type
18	Warning Trip Point High	Specified by Attrib. 3 & 4	Set	NV	Determines the Value[6] above which a warning condition will occur.	See Note 'Warnings' below [default] = Maximum value for its data type

Table 5-69 S-Analog Actuator Instance 1 Attributes (continued)

Attrib ID	Name	Data Type	Access Rule	NV	Description	Notes
19	Warning Trip Point Low	Specified by Attrib. 3 & 4	Set	NV	Determines the Value[6] below which a warning condition will occur.	See Note 'Warnings' below [default] = Minimum value for its data type
21	Safe State	USINT	Set	NV	Specifies the behavior for the physical actuator in an Operational State other than Executing State	See Note 'Safe State' below
22	Safe Value	Specified by Attrib. 3 & 4	Set	NV	The analog output signal value that is indicated by Attrib. 6 if the Safe State[21] is configured to "Use Safe Value"	Default = 0

5.8.1.1. Note: Data Type

The value of this attribute is limited to INT or REAL. This attribute can only be set when the device is not in the Operational State of Executing. If any of the attributes in this object use the attribute Data Type[3] to define their data type and the attribute is the end point of an active I/O connection, then the access rule for the attribute Data Type[3] becomes Get and thus cannot be set until the I/O connected becomes inactive. Additionally, the inferred data type of an Assembly object (see The "Inferred" Data Type) will modify this value if the Assembly object has been assigned to an active I/O connection.

Example 1:

If the value of Value[6] is being exchanged via the Polled I/O connection, attribute 3 cannot be modified until that Polled I/O Connection is terminated.

Example 2:

If Assembly instance 3 is assigned to the Polled I/O connection produce path, the value of attribute 3 will be set to INT when the Polled I/O connection transitions to the Active state. When the Polled I/O connection is terminated, the value of this attribute will remain INT. It will not return to the value prior to commissioning the Polled I/O connection.

5.8.1.2. Note: Data Units

The value of this attribute is limited to the values specified in the table in Appendix C - Actuator Data Units. This attribute can only be set when the device is not in the Operational State of Executing. See Example 1 above in Note: Data Type.

Brooks DeviceNet MFCs/MFMs

5.8.1.3. Note: Override

The following table outlines the valid actuator override types.

Table 5-70 Override

Value	State	Description
0	Normal	Actuator is under normal operational control
1	Closed	Actuator is driven fully closed (Value[6] = 0% or 0 Counts)
2	Open	Actuator is driven fully open (Value[6] = 100% or 24576 Counts)
3	Hold	Actuator is held to last updated analog output signal prior to assertion of override
4	Safe State	Actuator is driven to the condition specified by the Safe State[21] attribute

5.8.1.4. Note: Valve

To interpret the value of this attribute, it is important to understand the following terms:

Operational Range:

This is the range that is reported by Value[6]. The operational range of the actuator is full range that the actuator can be driven to move. This corresponds to Value[6] values of 0 to 100% (0 to 24576 Counts).

Nominal Control Range:

The nominal control range is a set of values that the actuator is driven to that maps directly between 0 flow and full scale flow. This set of values is a sub-range within the large operational range of the actuator. Example, the nominal control range for a 0 to 100 SCCM device flowing nitrogen could be as follows:

at 0 SCCM Actuator = 20% (4915 counts)

at 100 SCCM, Actuator = 30% (7373 counts)..

Under normal operational control (no override), the actuator generally operates in the nominal control range. The upper end of the control range is not an absolute limit under normal control. The controller will drive the actuator to whatever value is necessary to control flow. For example, if an restriction occurred upstream of the device resulting in reduced supply to the device, the controller will drive the actuator beyond the nominal control range to maintain control.

5.8.1.5. Note: Status

The following table defines the bits in this status byte. The value of 1 = Set and 0 = Cleared.

Table 5-71 Status

Bit 7	Bit 6	Bit 5	Bit 4	Bit 3	Bit 2	Bit 1	Bit 0
0	0	0	0	Low Warning	High Warning	Low Alarm	High Alarm

5.8.1.6. Note: Safe State

The following table outlines valid values for this attribute. This table applies for normally closed and normally open valves.

Table 5-72 Safe State

Value	State	Description
0	Closed	The actuator will be driven closed and the value of Value[6] will be 0% or 0 Counts
1	Open	The actuator will be driven open and the value of Value[6] will be 100% or 24576 Counts
2	Hold Last Value	The actuator will be driven to the last updated value of the analog output just prior to the entering of the safe state.
3	Use Safe Value	The actuator will be driven to the value configured in Safe Value[22] and Value[6] = Safe Value[22]

5.8.1.7. Note: Alarms

Enable the reporting of Alarms for the S-Analog Actuator object via Alarm Enable[8] attribute. When Value[6] exceeds the limits set by Alarm Trip Point High[15] or Alarm Trip Point Low[16] a corresponding bit from the Status[7] attribute is set, see Status above. If alarms are enabled in the S-Device Supervisor Object the actuator alarms are reported via the Exception Status [12] and corresponding Exception Detail Alarm[13] of the S-Device Supervisor Object.

Brooks DeviceNet MFCs/MFMs

5.8.1.8. Note: Warnings

Enable the reporting of Warnings for the S-Analog Actuator object via Warning Enable[9] attribute. When Value[6] exceeds the limits set by Warning Trip Point High[18] or Warning Trip Point Low[19] a corresponding bit from the Status[7] attribute is set, see Status above. If warnings are enabled in the S-Device Supervisor Object the actuator warnings are reported via the Exception Status [12] and corresponding Exception Detail Warning[14] of the S-Device Supervisor Object.

5.8.2. Services*Table 5-73 S-Analog Actuator Instance 0 Services*

Service Code	Service Name	Service Description	Details
0x0E	Get Attribute Single	Returns the contents of the specified attribute	Appendix E: Get Attribute Single

Table 5-74 S-Analog Actuator Instance 1 Services

Service Code	Service Name	Service Description	Details
0x0E	Get Attribute Single	Returns the contents of the specified attribute	Appendix E: Get Attribute Single
0x10	Set Attribute Single	Sets the contents of the specified attribute with the value passed with this service	Appendix E: Set Attribute Single

5.8.2.1. Service Details

NONE

5.9. S-Single Stage Controller Object [0x33]

The S-Single Stage Controller object is responsible for closing the loop between the measured process variable (via the S-Analog Sensor) and the control variable (via the S-Analog Actuator).

5.9.1. Attributes

Table 5-75 S-Single Stage Controller Instance 0 Attributes

Attrib ID	Name	Data Type	Access Rule	NV	Description	Notes
1	Revision	UINT	Get	NV	Revision of the S-Single Stage Controller object class definition upon which the implementation is based.	If updates require an increase in this value, then the value of this attribute increases by 1. Range 1– 65535
100	Active Instance	USINT	Set	NV	Denotes the instance (n) of the S-Single Stage Controller that is actively processing the control loop. This loop drives the actuator to null the difference between process value and Setpoint[101] Instance 0 and Setpoint[6] Instance n.	The MFC Device Type supports only Instance 1 of the S-Single Stage Controller. Default = 1.
101	Setpoint	Specified by Attrib. 3 & 4 of the Active Instance[100]	Set	V	This attribute mirrors the Setpoint[6] Instance n attribute, where n equals the Active Instance[100].	In an MFC, Setpoint[101] mirrors Setpoint[6] of Instance One.
102	Mode	USINT	Get	NV	Identifies a Device Type specific controller mode.	Default = 0 [flow control] Range = 0.

Brooks DeviceNet MFCs/MFMs

Table 5-76 S-Single Stage Controller Instance 1 Attributes

Attrib ID	Name	Data Type	Access Rule	NV	Description	Notes
3	Data Type	USINT	Cond.	NV	Defines the Data Type of Setpoint[6] and other attributes in this object.	See 'Note: Data Type' below Default = INT
4	Data Units	ENGUNITS	Cond.	NV	Defines the Engineering Units context of Setpoint[6] and other attributes in this object	See 'Note: Data Units' below Default = Counts
6	Setpoint	Specified by Attrib. 3 & 4	Set	V	The sensor value that the device will maintain at steady state condition.	
10	Status	BYTE	Get	V	Alarm and Warning status for the S-Single Stage Controller Object	See 'Note: Status' below
11	Alarm Enable	BOOL	Set	NV	Enables setting of the Alarm bit	See 'Note: Alarms' below 0 = disabled [default] 1 = enabled
12	Warning Enable	BOOL	Set	NV	Enables setting of the Warning bit	See 'Note: Warnings' below 0 = disabled [default] 1 = enabled
13	Alarm Settling Time	UINT	Set	NV	Number of milliseconds allowed for the control-loop to settle to within the error band	See 'Note: Alarms' below Default = 0
14	Alarm Error Band	Specified by Attrib. 3 & 4	Set	NV	The maximum deviation band by which Setpoint must equal the Process Variable before an alarm is enunciated.	See 'Note: Alarms' below Default = 0
15	Warning Settling Time	UINT	Set	NV	Number of milliseconds allowed for the control-loop to settle to within the error band	See 'Note: Warnings' below Default = 0
16	Warning Error Band	Specified by Attrib. 3 & 4	Set	NV	The maximum deviation band by which Setpoint must equal the Process Variable before an warning is enunciated.	See 'Note: Warnings' below Default = 0

Table 5-76 S-Single Stage Controller Instance 1 Attributes (continued)

Attrib ID	Name	Data Type	Access Rule	NV	Description	Notes
19	Constant Time Ramp Rate	UDINT	Set	NV	The amount of time, in milliseconds, the controller will take to "ramp" flow from its current value to its final value as commanded in Setpoint[6]	Default = 0 [disabled]
92	Derivative Gain (Kd)	REAL	Set	NV	The gain factor for the derivative term of the PID control compensation	See 'Note: PID Gains' below
93	Integral Gain (Ki)	REAL	Set	NV	The gain factor for the integral term of the PID control compensation	See 'Note: PID Gains' below
94	Proportional Gain (Kp)	REAL	Set	NV	The gain factor for the proportional term of the PID control compensation	See 'Note: PID Gains' below
99	Subclass	UINT	Get	NV	Identifies a subset of additional instance attributes, services, and behaviors for the Sensor Object	1 = PID & Source Select
101	Derivative Gain (Kd)	REAL	Set	NV	The gain factor for the derivative term of the PID control compensation	Included for backward compatibility with older SLA models only! New users please use attribute 92
102	Integral Gain (Ki)	REAL	Set	NV	The gain factor for the integral term of the PID control compensation	Included for backward compatibility with older SLA models only! New users please use attribute 93
103	Proportional Gain (Kp)	REAL	Set	NV	The gain factor for the proportional term of the PID control compensation	Included for backward compatibility with older SLA models only! New users please use attribute 94

Brooks DeviceNet MFCs/MFMs

5.9.1.1. Note: Data Type

The value of this attribute is limited to INT or REAL. This attribute can only be set when the device is not in the Operational State of Executing. If any of the attributes in this object use the attribute Data Type[3] to define their data type and the attribute is the end point of an active I/O connection, then the access rule for the attribute Data Type[3] becomes Get and thus cannot be set until the I/O connection becomes inactive. Additionally, the inferred data type of an Assembly object (see The “Inferred” Data Type) will modify this value if the Assembly object has been assigned to an active I/O connection.

Example 1:

If the value of Setpoint[6] is exchanged via the Polled I/O connection, Data Type[3] cannot be modified until that Polled I/O Connection is terminated.

Example 2:

If Assembly instance 7 is assigned to the Polled I/O connection consume path, the value of Data Type[3] will be set to INT when the Polled I/O connection transitions to the Active state. When the Polled I/O connection is terminated, the value of this attribute will remain INT. It will not return to the value prior to commissioning the Polled I/O connection.

5.9.1.2. Note: Data Units

The value of this attribute is limited to the values specified in the Volumetric Flow Units Table and Mass Flow Units table in Appendix C - Data Units. This attribute can only be set when the device is not in the Operational State of Executing. See Example 1 above in Note: Data Type.

5.9.1.3. Note: Status

The following table defines the bits in this status byte. The value of 1 = Set and 0 = Cleared.

Table 5-77 Status

Bit 7	Bit 6	Bit 5	Bit 4	Bit 3	Bit 2	Bit 1	Bit 0
0	0	0	0	0	0	Controller Warning	Controller Alarm

5.9.1.4. Note: Alarms

Enable the reporting of Alarms for the S-Single Stage Controller via Alarm Enable[11] attribute. When the process value (Flow) exceeds Setpoint[6] by the limits established by Alarm Error Band [14] a corresponding bit from the Status[7] attribute is set, see Status above.

The attribute Alarm Settling Time[13] sets the interval of a timer that masks the reporting of alarms until the control loop can stabilize the process value (Flow) on the commanded Setpoint[6]. Once the timer expires if an alarm condition still exists the warning is reported.

If alarms are enabled in the S-Device Supervisor Object the controller alarms are reported via the Exception Status [12] and corresponding Exception Detail Alarm[13] of the S-Device Supervisor Object.

5.9.1.5. Note: Warnings

Enable the reporting of Warnings for the S-Single Stage Controller object via Warning Enable[12] attribute. When the process value (Flow) exceeds Setpoint[6] by the limits established by Warning Error Band [16] a corresponding bit from the Status[7] attribute is set, see Status above.

The attribute Warning Settling Time[15] sets the interval of a timer that masks the reporting of warnings until the control loop can stabilize the process value (Flow) on the commanded Setpoint[6]. Once the timer expires if a warning condition still exists the warning is reported.

If warnings are enabled in the S-Device Supervisor Object the controller warnings are reported via the Exception Status [12] and corresponding Exception Detail Warning[14] of the S-Device Supervisor Object.

5.9.1.6. Note: PID Gains

The MFC device utilizes a PID compensator in the control loop as a means of optimizing and tuning control. The attributes are scalar numbers used as multipliers for their respective P, I, and D terms.

Brooks DeviceNet MFCs/MFMs

5.9.2. Services

Table 5-78 S-Single Stage Controller Instance 0 Services

Service Code	Service Name	Service Description	Details
0x0E	Get Attribute Single	Returns the contents of the specified attribute	Appendix E: Get Attribute Single
0x10	Set Attribute Single	Sets the contents of the specified attribute with the value passed with this service	Appendix E: Set Attribute Single

Table 5-79 S-Single Stage Controller Instance 1 Services

Service Code	Service Name	Service Description	Details
0x0E	Get Attribute Single	Returns the contents of the specified attribute	Appendix E: Get Attribute Single
0x10	Set Attribute Single	Sets the contents of the specified attribute with the value passed with this service	Appendix E: Set Attribute Single

5.9.2.1. Service Details

NONE

5.10. S-Gas Calibration Object [0x34]

The S-Gas Calibration object defines characteristics associated with linearization/compensation of the gas flow sensor.

5.10.1. Attributes

Table 5-80 S-Gas Calibration Instance 0 Attributes

Attrib ID	Name	Data Type	Access Rule	NV	Description	Notes
1	Revision	UINT	Get	NV	Revision of the S-Gas Calibration object class definition upon which the implementation is based.	If updates require an increase in this value, then the value of this attribute increases by 1. Range 1– 65535

Table 5-81 S-Gas Calibration Instance 1..n Attributes

Attrib ID	Name	Data Type	Access Rule	NV	Description	Notes
3	Gas Standard Number	UINT	Get	NV	The gas type number assigned to this gas	See Note 'Gas Standard Number' below Default = 0, no gas type specified.
4	Valid Sensor Instance	UINT	Get	NV	The instance of the S-Analog Sensor Object that this Gas Calibration Object is valid	Default = 1
5	Gas Symbol	Short String	Set	NV	Gas Type Name	Default = null
6	Full Scale	STRUCT of:	Get	NV	Represents the maximum calibrated flow value.	
	Amount	REAL			The amount of flow corresponding to full scale	
	Units	ENGUNITS			The engineering units assigned to the above	

Brooks DeviceNet MFCs/MFMs

Table 5-81 S-Gas Calibration Instance 1..n Attributes (continued)

Attrib ID	Name	Data Type	Access Rule	NV	Description	Notes
7	Additional Scalar	REAL	Set	NV	Additional correction factor	In addition to the algorithm, this amount is multiplied by the reading. Generally used for gas correction for a gas other than the type identified for the object instance by attribute 3. (e.g., scale a nitrogen object instance to measure argon) . Default = 1.0
8	Calibration Date	UINT	Get	NV	Date of Calibration	The date this object was calibrated. Default = 1.0
9	Calibration Gas Number	UINT	Get	NV	Calibration Gas	The gas number of the gas used to calibrate this object instance. Default = 0
10	Gas Correction Factor	REAL	Get	NV	A simple scalar number used to correct the flow sensor reading	See Note 'Gas Correction Factor' below
95	Calibration Pressure	REAL	Get	NV	The gas pressure, in Pa, under which this calibration was performed	Default = 101325 Pa
96	Calibration Temperature	REAL	Get	NV	The gas temperature, in Celsius, under which this calibration was performed	Default = 0.0 C
99	Subclass	UINT	Get	NV	Identifies a subset of additional instance attributes, services, and behaviors for the S-Gas Calibration Object	The value of this attribute is 1 = Standard T & P subclass
100	Gas Correction Type	USINT	Get	NV	The Gas Correction Method this calibration utilizes	See Note 'Gas Correction Type' below
101	Customer Full Scale	REAL	Set	NV	A user configurable attribute to rescale the Full Scale value of this calibration object	See Note 'Customer Full Scale' below
170	Bin ID	INT	Get	NV	Configurable on a per customer basis.	Intended to be used as a aid in tracking Brooks Instrument to Customer Part Number assignments.
171	Gas Table Revision	UINT	Get		Revision of the supported Gas Table.	Starts at 1 and increases with later revisions in whole number increments.

5.10.1.1. Note: Gas Standard Number

The Gas Standard Number as defined by SEMI publication SEMI E52-0298, "Practice for Referencing Gases Used in Digital Mass Flow Controllers."

5.10.1.2. Note: Gas Correction Factor

This correction factor is used to correct for the sensor value if this calibration instance was calibrated using a calibration gas that is different from the gas this calibration instance represents.

This attribute is no longer used by the SLA to adjust for a gas other than the calibration gas. To create a gas calibration for a new gas, use the Brooks Service Suite tool to prepare the device for the new gas.

5.10.1.3. Note: Gas Correction Type

The SLA5800 Series MFC/MFM supports only one type of gas correction. The method is proprietary to Brooks Instrument. The Gas Correction Type attribute always returns a value of 1, Empirical.

Table 5-82 Gas Correction Type

Attribute Value	Correction Method	Description
1	Empirical	

5.10.1.4. Note: Customer Full Scale

This attributes provides a means to rescale the Full Scale value of this calibration instance. By default, it will equal the Full Scale[6] attribute.

NOTE:

There is no limitation on changing this attribute. It is recommended that the customer consult with a Brooks Instrument service representative or engineer about their particular application before changing this attribute.

Brooks DeviceNet MFCs/MFMs

5.10.2. Services

Table 5-83 S-Gas Calibration Instance 0 Services

Service Code	Service Name	Service Description	Details
0x0E	Get Attribute Single	Returns the contents of the specified attribute	Appendix E: Get Attribute Single
0x4B	Get All Instances	Returns all S-Gas Calibration Instance objects	Get All Instances

Table 5-84 S-Gas Calibration Instance 1..n Services

Service Code	Service Name	Service Description	Details
0x0E	Get Attribute Single	Returns the contents of the specified attribute	Appendix E: Get Attribute Single
0x10	Set Attribute Single	Sets the contents of the specified attribute with the value passed with this service	Appendix E: Set Attribute Single

5.10.2.1. Service Details

NONE

5.10.2.1.1. Get All Instances

Table 5-85 Get All Instances Arguments

Parameter Name	Data Type	Required	Parameter Value	Semantics
NONE				

Table 5-86 Get All Instances Response

Parameter Name	Data Type	Required	Parameter Value	Description
Size of List	UINT	Y		Specifies the number of elements in the following ARRAY
List of Gas Calibrations	ARRAY of:	Y		Supported List. This list is an array of structures
	STRUCT of:			
Calibration Instance ID	UINT			S-Gas Calibration Object Instance ID
Gas Standard Number	UINT			Gas Standard Number
Sensor Instance ID	UINT			Valid Sensor Instance

6. Troubleshooting

Problem	Possible Causes
Scanner is actively scanning the network, but the NET LED is flashing green	The MAC ID of the device is not programmed in the scan list of the scanner or does not match a MAC ID already programmed in the scanner
Scanner is actively scanning the network, but the NET LED on the device alternates between solid green state for a short time, then flashing green state for a short time.	Produce/Consume I/O data size mismatch. The I/O data sizes programmed in the scanner is different from the Produce/Consume I/O data size in the device
When power is applied to the device network communications are disrupted	The Power Supply for the network is undersized to handle the additional load, causing the power supply to "droop" The baud rate setting on the device does not match the network baud rate.
When power is applied to the device the NET LED and MOD LED goes solid red	The MAC ID of the device is the same as the MAC ID of another device on the network. The Baud Rate switch setting on the device does not match the network baud rate. The device was forced off the bus because of communications error (a.k.a. Bus Off condition). If the problem persists, contact Brooks service.
When power is applied to the device the NET LED remains off	The device is the only device connected on the network.
The NET LED is flashing red	The I/O connection is timed out.
The device never comes out of Self-Test (MOD LED continually flashes red/green).	Cycle power to the device. If problem persists, contact Brooks service.
The MOD LED is solid RED	An internal fault in the device was detected. Cycle power to the device. If the problem persists, contact Brooks service.
When power is applied to the device both LED's continually cycle through the power-on LED test (each LED will cycle red then green).	An internal fault has occurred in the device on power-up. Contact Brooks service.
A setpoint value is being sent to the device, but the MFC fails control flow (i.e. no actuator movement, low or no flow indication)	Check Data Units for the Sensor Object and Controller Object. Make sure the Data Units for both match and that they configured to the desired values. If a CYC or COS I/O connection is the only established I/O Connection the device must be forced to the Executing state by a S-Device Supervisor Object Start service via Explicit messaging.

*THIS PAGE WAS
INTENTIONALLY
LEFT BLANK*

7. Appendix

7.1. Appendix A - Assembly Object Detail

The following table details each of the Assembly Objects supported by the MFC. The DeviceNet specification defines Input and Output relative to the network (i.e. The data being PRODUCED from the device as an INPUT into the network or the data being CONSUMED by the device is an OUTPUT from the network).

Table 7-1 Summary Table of Input Assemblies

Instance ID	Data Description	Size(bytes)	Data Type
1	Flow	2	INT
2	Status, Flow	3	INT
3	Status, Flow, Valve	5	INT
4	Status, Flow, Setpoint	5	INT
5	Status, Flow, Setpoint, Valve	7	INT
6	Status, Flow, Setpoint, Actuator Override, Valve	8	INT
13	Flow	4	REAL
14	Status, Flow	5	REAL
15	Status, Flow, Valve	9	REAL
16	Status, Flow, Setpoint	9	REAL
17	Status, Flow, Setpoint, Valve	13	REAL
18	Status, Flow, Setpoint, Actuator Override, Valve	14	REAL

Table 7-2 Summary Table of Output Assemblies

Instance ID	Data Description	Size(bytes)	Data Type
7	Setpoint	2	INT
8	Actuator Override, Setpoint	3	INT
19	Setpoint	4	REAL
20	Actuator Override, Setpoint	5	REAL

Brooks DeviceNet MFCs/MFMs

7.1.1. Assembly Details

Table 7-3 Input Assembly 1

Assembly Instance	1	
Data Size	2 bytes	
Type	Input	
Definition of Bytes	Description	EPATH
Byte 0	Flow	[0x31-1-6]
Byte 1		

Table 7-4 Input Assembly 2

Assembly Instance	2	
Data Size	3 bytes	
Type	Input	
Definition of Bytes	Description	EPATH
Byte 0	Status	[0x30-1-12]
Byte 1	Flow	[0x31-1-6]
Byte 2		

Table 7-5 Input Assembly 3

Assembly Instance	3	
Data Size	5 bytes	
Type	Input	
Definition of Bytes	Description	EPATH
Byte 0	Status	[0x30-1-12]
Byte 1	Flow	[0x31-1-6]
Byte 2		
Byte 3	Valve	[0x32-1-6]
Byte 4		

Table 7-6 Input Assembly 4

Assembly Instance	4		
Data Size	5 bytes		
Type	Input		
Definition of Bytes	Description	EPATH	
Byte 0	Status	[0x30-1-12]	
Byte 1	Flow	[0x31-1-6]	
Byte 2			
Byte 3	Setpoint	[0x33-1-6]	
Byte 4			

Table 7-7 Input Assembly 5

Assembly Instance	5		
Data Size	7 bytes		
Type	Input		
Definition of Bytes	Description	EPATH	
Byte 0	Status	[0x30-1-12]	
Byte 1	Flow	[0x31-1-6]	
Byte 2			
Byte 3	Setpoint	[0x33-1-6]	
Byte 4			
Byte 5	Valve	[0x32-1-6]	
Byte 6			

Brooks DeviceNet MFCs/MFMs

Table 7-8 Input Assembly 6

Assembly Instance	6	
Data Size	8 bytes	
Type	Input	
Definition of Bytes	Description	EPATH
Byte 0	Status	[0x30-1-12]
Byte 1	Flow	[0x31-1-6]
Byte 2		
Byte 3	Setpoint	[0x33-1-6]
Byte 4		
Byte 5	Actuator Override	[0x32-1-5]
Byte 6	Valve	[0x32-1-6]
Byte 7		

Table 7-9 Output Assembly 7

Assembly Instance	7	
Data Size	2 bytes	
Type	Output	
Definition of Bytes	Description	EPATH
Byte 0	Setpoint	[0x33-1-6]
Byte 1		

Table 7-10 Output Assembly 8

Assembly Instance	8	
Data Size	3 bytes	
Type	Output	
Definition of Bytes	Description	EPATH
Byte 0	Actuator Override	[0x32-1-5]
Byte 1	Setpoint	[0x33-1-6]
Byte 2		

Table 7-11 Input Assembly 13

Assembly Instance	13	
Data Size	4 bytes	
Type	Input	
Definition of Bytes	Description	EPATH
Byte 0	Flow	[0x31-1-6]
Byte 1		
Byte 2		
Byte 3		

Table 7-12 Input Assembly 14

Assembly Instance	14	
Data Size	5 bytes	
Type	Input	
Definition of Bytes	Description	EPATH
Byte 0	Status	[0x30-1-12]
Byte 1	Flow	[0x31-1-6]
Byte 2		
Byte 3		
Byte 4		

Brooks DeviceNet MFCs/MFMs

Table 7-13 Input Assembly 15

Assembly Instance	15	
Data Size	9 bytes	
Type	Input	
Definition of Bytes	Description	EPATH
Byte 0	Status	[0x30-1-12]
Byte 1	Flow	[0x31-1-6]
Byte 2		
Byte 3		
Byte 4		
Byte 5	Valve	[0x32-1-6]
Byte 6		
Byte 7		
Byte 8		

Table 7-14 Input Assembly 16

Assembly Instance	16	
Data Size	9 bytes	
Type	Input	
Definition of Bytes	Description	EPATH
Byte 0	Status	[0x30-1-12]
Byte 1	Flow	[0x31-1-6]
Byte 2		
Byte 3		
Byte 4		
Byte 5	Setpoint	[0x33-1-6]
Byte 6		
Byte 7		
Byte 8		

Table 7-15 Input Assembly 17

Assembly Instance	17	
Data Size	13 bytes	
Type	Input	
Definition of Bytes	Description	EPATH
Byte 0	Status	[0x30-1-12]
Byte 1	Flow	[0x31-1-6]
Byte 2		
Byte 3		
Byte 4		
Byte 5	Setpoint	[0x33-1-6]
Byte 6		
Byte 7		
Byte 8		
Byte 9	Valve	[0x32-1-6]
Byte 10		
Byte 11		
Byte 12		

Brooks DeviceNet MFCs/MFMs

Table 7-16 Input Assembly 18

Assembly Instance	18	
Data Size	14 bytes	
Type	Input	
Definition of Bytes	Description	EPATH
Byte 0	Status	[0x30-1-12]
Byte 1	Flow	[0x31-1-6]
Byte 2		
Byte 3		
Byte 4		
Byte 5	Setpoint	[0x33-1-6]
Byte 6		
Byte 7		
Byte 8		
Byte 9	Actuator Override	[0x32-1-5]
Byte 10	Valve	[0x32-1-6]
Byte 11		
Byte 12		
Byte 13		

Table 7-17 Output Assembly 19

Assembly Instance	19	
Data Size	4 bytes	
Type	Output	
Definition of Bytes	Description	EPATH
Byte 0	Setpoint	[0x33-1-6]
Byte 1		
Byte 2		
Byte 3		

Table 7-18 Output Assembly 20

Assembly Instance	20	
Data Size	5 bytes	
Type	Output	
Definition of Bytes	Description	EPATH
Byte 0	Actuator Override	[0x32-1-5]
Byte 1	Setpoint	[0x33-1-6]
Byte 2		
Byte 3		
Byte 4		

Brooks DeviceNet MFCs/MFMs

7.2. Appendix B - Data Type Definitions

The following table list DeviceNet data types used throughout this manual and in the DeviceNet specification. The column C/C++ Encoding is given as a comparative common example reference.

Table 7-19 Data Types

Data Type	Size (bytes)	Description	Range	C/C++ Keyword
BOOL	1	A true/false represented as 0 = false and 1 = true	0 and 1	bool
SINT	1	An 8-bit signed integer value	-128 to 127	char
USINT	1	An 8-bit unsigned integer value	0 to 255	unsigned char
INT	2	A 16-bit signed integer value	-32768 to 32767	short int
UINT	2	A 16-bit unsigned integer value	0 to 65535	unsigned short int
DINT	4	A 32-bit signed integer value	-2147483648 to 2147483647	int
UDINT	4	A 32-bit unsigned integer	0 to 4294967296	unsigned int
REAL	4	An IEEE single precision floating point number	3.4E38 to -3.4E38	float
DREAL	8	An IEEE double precision floating point number		Long
ENGUNIT	1	An enumerated value representing an engineering unit of measure	4096 - 65535	N/A
BYTE	1	An 8-bit Bitfield	N/A	N/A
SHORT STRING	Up to 128 bytes	A character array where the first byte is the number of characters in the array, and the subsequent bytes contain the ASCII characters. This is not a NULL terminated string.	N/A	N/A

7.3. Appendix C – Data Units

Table 7-20 Volumetric Flow Units

Description	Symbol	Units Code	
		Decimal	Hex
barrels per day	bb/d	2072	0x0818
barrels per hour	bb/h	2071	0x0817
barrels per minute	bb/min	2070	0x0816
barrels per second	bb/s	2069	0x0815
counts	-	4097	0x1001
cubic centimeter per day	cc/d	2051	0x0803
cubic centimeter per hour	cc/h	2050	0x0802
cubic centimeter per minute	cc/min	2049	0x0801
cubic centimeter per second	cc/s	2048	0x0800
cubic feet per day	ft3/d	2059	0x080B
cubic feet per hour	ft3/h	2058	0x080A
cubic feet per second	ft3/s	2057	0x0809
cubic foot per minute	ft3/min	5122	0x1402
cubic inches per day	in3/d	2063	0x080F
cubic inches per hour	in3/h	2062	0x080E
cubic inches per min	in3/min	2061	0x080D
cubic inches per second	in3/s	2060	0x080C
cubic meter per second	m3/s	5125	0x1405
cubic meters per day	m3/d	2056	0x0808
cubic meters per hour	m3/h	2055	0x0807
cubic meters per minute	m3/min	2054	0x0806
gallon per day	gal/d	2064	0x0810
gallon per hour	gal/h	5130	0x140A
gallon per minute	gal/min	5129	0x1409
gallon per second	gal/s	5128	0x1408

Brooks DeviceNet MFCs/MFMs

Table 7-20 Volumetric Flow Units (continued)

Description	Symbol	Units Code	
		Decimal	Hex
imperial gallon per day	igal/d	2068	0x0814
imperial gallon per hour	igal/h	2067	0x0813
imperial gallon per minute	igal/min	2066	0x0812
imperial gallon per second	igal/s	2065	0x0811
liter per second	l/s	5126	0x1406
liters per day	l/d	2053	0x0805
liters per hour	l/h	5140	0x1414
liters per minute	l/min	5139	0x1413
milliliter per second	ml/s	5127	0x1407
milliliters per day	ml/d	2052	0x0804
milliliters per hour	ml/h	5138	0x1412
milliliters per minute	ml/min	5137	0x1411
percent	%	4103	0x1007
standard cubic centimeter per minute	SCCM	5120	0x1400
standard liter per minute	SLM	5121	0x1401

Brooks DeviceNet MFCs/MFMs

Table 7-21 Mass Flow Units

Description	Symbol	Units Code	
		Decimal	Hex
counts	-	4097	0x1001
grams per day	g/d	2075	0x081B
grams per hour	g/h	2074	0x081A
grams per minute	g/min	5135	0x140F
grams per second	g/s	2073	0x0819
kilogram per second	kg/s	5124	0x1404
kilograms per day	kg/d	2077	0x081D
kilograms per hour	kg/h	5136	0x1410
kilograms per minute	kg/min	2076	0x081C
ounces per day	oz/d	2082	0x0822
ounces per hour	oz/h	2081	0x0821
ounces per minute	oz/min	2080	0x0820
ounces per second	oz/s	2079	0x081F
percent	%	4103	0x1007
pound per hour	lb/h	5133	0x140D
pound per minute	lb/min	5132	0x140C
pound per second	lb/s	5131	0x140B
pounds per day	lbs/d	2028	0x081E

Table 7-22 Actuator Units

Description	Symbol	Units Code	
		Decimal	Hex
Counts	-	4097	0x1001
Percent	%	4103	0x1007

Brooks DeviceNet MFCs/MFMs

7.4. Appendix D - LED Flash Codes

The following tables assume power has been applied to the network and the device has been properly connected to the network.

Table 7-23 NET LED Flash Codes

Flash Code	Description
Off	The device is the only node on the network
Flashing Green	Baud Rate and MAC ID are configured correctly. The device recognizes the network but no connection has been made to the device
Solid Green	A Connection has been established to the device
Flashing Red	An I/O Connection to the device has timed out
Solid Red	The Baud Rate Switch is set to a different baud rate than the network OR The MAC ID of the device is identical to another node on the network OR The device has gone Bus Off, indicating network communication errors.

Table 7-24 MOD LED Flash Codes

Flash Code	Description
Flashing Red-Green	The device is in the Self-Test mode
Solid Green	All self-tests have passed. No faults have been detected
Flashing Red	A recoverable fault has been detected or the device has been commanded into the Abort state
Solid Red	An unrecoverable fault has occurred

7.5. Appendix E – Service Summary and Details

Table 7-25 Get Attribute Single Service Parameters

Parameter Name	Data Type	Required	Description	Default
Attribute ID	USINT	Y	The attribute ID of the attribute to be read.	None

Table 7-26 Success Response Data

Return Value	Data Type	Description
Attribute Value	The Data Type of the Attribute being read	

Table 7-27 Set Attribute Single Service Parameters

Parameter Name	Data Type	Required	Description	Default
Attribute ID	USINT	Y	The attribute ID of the attribute to be read.	None
Attribute Value	(Equivalent to the data type of the Attribute)	Y	The value to which the attribute will be set	None

Table 7-28 Success Response Data

Return Value	Data Type	Description
NO SUCCESS RESPONSE DATA		

Brooks DeviceNet MFCs/MFMs

7.6. Appendix F - State

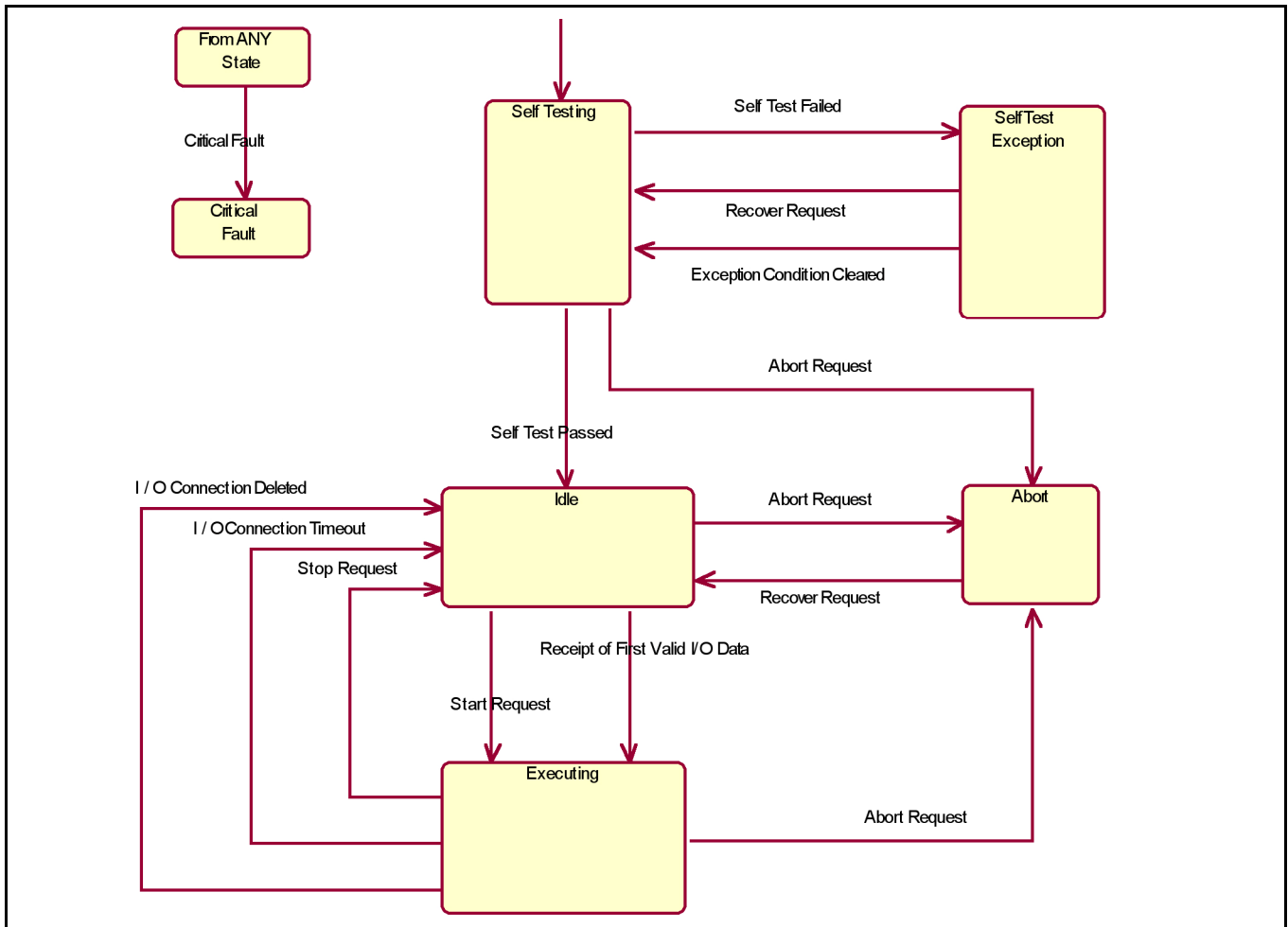

Figure 7-1 S-Device Supervisor State Machine Diagram

Table 7-29 S-Device Supervisor State Event Matrix

EVENT	STATE					
	Idle	Self-Testing	Self-Test Exception	Executing	Abort (Recoverable Fault)	Critical Fault
Power Applied	-	Default Entry Point: Device performs its Self-Test Application Process	-	-	-	Transition to SELF-TESTING
Self-Test Passed	Not Applicable	Transition to IDLE	Not Applicable	Not Applicable	Not Applicable	Not Applicable
Self-Test Failed	Not Applicable	Set appropriate Exception Status Bits and Transition to SELF-TEST EXCEPTION	Not Applicable	Not Applicable	Not Applicable	Not Applicable
Exception Condition Cleared	Not Applicable	Not Applicable	Set appropriate Exception Status Bits and Transition to SELF-TESTING	Not Applicable	Not Applicable	Not Applicable
Critical Fault	Transition to CRITICAL FAULT	Transition to CRITICAL FAULT	Transition to CRITICAL FAULT	Transition to CRITICAL FAULT	Transition to CRITICAL FAULT	Ignore Event
Reset Request	Transition to SELF-TESTING	Restart SELF-TESTING	Transition to SELF-TESTING	Transition to SELF-TESTING	Transition to SELF-TESTING	Ignore Event
Start Request	Transition to EXECUTING	Error OSC ¹	Error OSC ¹	Error AIRS ²	Error OSC ¹	Ignore Event
Stop Request	Error AIRS ²	Error OSC ¹	Error OSC ¹	Transition to IDLE	Error OSC ¹	Ignore Event
Abort Request	Transition to ABORT	Transition to ABORT	Error OSC ¹	Transition to ABORT	Error AIRS ²	Ignore Event
Recover Request	Error OSC ¹	Restart SELF-TESTING	Transition to SELF-TESTING	Error OSC ¹	Transition to IDLE	Ignore Event
Perform Diagnostics Request	Transition to SELF-TESTING	Restart SELF-TESTING	Transition to SELF-TESTING	Transition to SELF-TESTING	Perform all device diagnostics test.	Ignore Event
Connection Timeout	Ignore Event	Ignore Event	Ignore Event	Transition to IDLE	Ignore Event	Ignore Event

¹ Error OSC = Error Response "Object State Conflict" (Code 0C_{hex})

² Error AIRS = Error Response "Already in Requested Mode/State" (Code 0B_{hex})

Brooks DeviceNet MFCs/MFMs

Table 7-29 S-Device Supervisor State Event Matrix (continued)

EVENT	STATE					
	Idle	Self-Testing	Self-Test Exception	Executing	Abort (Recoverable Fault)	Critical Fault
Receipt of First Valid I/O Data	Transition to EXECUTING	Ignore Event	Ignore Event	Normal Response	Ignore Event	Ignore Event
I/O Connection Deleted	Ignore Event	Ignore Event	Ignore Event	Transition to IDLE	Ignore Event	Ignore Event

7.7. Appendix G - EDS Parameter Configuration

This section describes the parameters defined in the EDS file. These parameters are grouped logically in the following categories:

Table 7-30 Parameter Groups

Group Number	Group Name	Description
1	Polled Connection	These parameters select the I/O Data Assembly to be used with the Polled I/O Connection. The attributes associated with these parameters are found in the Connection Object – Explicit Connection Instance.
2	Device Info	These are informational parameters. The attributes associated with these parameters are found in the S-Device Supervisor Object.
3	Flow Sensor	These parameters are associated with configuring the flow sensor. The attributes associated with these parameters are found in the S-Analog Sensor Object.
4	Valve	These parameters are associated with configuring the Valve. The attributes associated with these parameters are found in the S-Analog Actuator Object.
5	Flow Control	These parameters are associated with configuring the flow control behavior. The attributes associated with these parameters are found in the S-Single Stage Controller Object.
6	Soft-start Control	These parameters configure the soft-start control (ramping) feature of the device. The attributes associated with these parameters are found in the S-Single Stage Controller Object.
7	Alarms and Warnings	These parameters are used to enable or disable reporting of both the individual and overall device alarms and warnings. The attributes associated with these parameters are found in the S-Device Supervisor Object, S-Analog Sensor Object, S-Analog Actuator Object and S-Single Stage Controller Object.

Brooks DeviceNet MFCs/MFMs

7.7.1. Flow Sensor Group

Table 7-31 Supported Flow Sensor Parameters

EDS Parameter	Values	Description	EPATH
Flow Sensor Data Type ^{1,2,3}	Appendix B - Data Type Definitions	The data type associated with reporting flow	[0x31-1-3]
Flow Sensor Data Units ²	See "Volumetric Units Table" and "Mass Units Table" in Appendix C -Data Units	The engineering units associated with reporting flow	[0x31-1-4]
Flow Sensor Safe State	See Note: Flow Sensor Safe State below	Configures the behavior of the flow sensor when the device is in Safe Mode	[0x31-1-25]
Flow Sensor Gas Cal Instance	From one up to the number of calibrations in the device	Sets the calibration curve used by the sensor to linearize the flow sensor values	[0x31-1-35]

7.7.1.1. Flow Sensor Safe State Values

The following table outlines valid values for the Flow Sensor's safe state parameter.

Table 7-32 Flow Sensor Safe State Values

Value	State	Description
0	Zero (default)	The sensor value will be zero
1	Full Scale	The sensor value will equal Full Scale
2	Hold Last Value	The sensor value will hold to the most recent sensor reading just prior to entering the safe state
3	Use Safe Value	The sensor value will equal Safe Value attribute of the S-Analog Sensor Object
100	Track	The sensor value will continue to update normally as if in the Executing State

¹ This parameter is only configurable when the device is in the Idle State (i.e. when the device is not being actively scanned/pollled).

² This parameter will automatically be set based upon the inferred data type of the selected Assembly used for I/O (i.e. if the Assembly that is selected to report flow is INT, then this attribute will be automatically set to INT once I/O data exchange begins).

³ The device only supports values INT and REAL. All others will be rejected.

7.7.2. Valve Group

Table 7-33 Supported Valve Parameters

EDS Parameter	Values	Description	EPATH
Valve Data Type ^{1, 2}	Appendix B - Data Type Definitions	The data type associated with reporting valve position.	[0x32-1-3]
Valve Data Units ^{1, 2}	See the Actuator Units Table Appendix C - Data Units	The engineering units associated with reporting valve position.	[0x32-1-4]
Valve Safe State	See Note: Valve Safe State below	Configures the behavior of the valve when the device is in Safe Mode.	[0x32-1-21]
Valve Override ³	See Note: Valve Override below	Overrides the controller by commanding the valve to one of the selectable values in the table below.	[0x32-1-5]

7.7.2.1. Valve Safe State Values

The following table outlines valid values for the valve's safe state parameter. This table applies for normally closed and normally open valves.

Table 7-34 Valve Safe State Values

Value	State	Description
0	Closed	The valve will be driven closed and the valve position will be 0% or 0 Counts.
1	Open	The valve will be driven open and the valve position will be 100% or Full Scale Counts Value.
2	Hold Last Value	The valve will be driven to the last updated value just prior to the entering of Safe Mode.
3	Use Safe Value	The valve will be driven to the value configured in the Safe Value attribute of the S-Analog Actuator

¹ This parameter is only configurable when the device is in the Idle State (i.e. when the device is not being actively scanned/pollled).

² This parameter will automatically be set based upon the inferred data type of the selected Assembly used for I/O (i.e. if an Assembly is selected that reports valve position, and the inferred data type of the assembly is INT, then this attribute will be automatically set to INT once I/O data exchange begins)

³ This Override action only occurs when the device is in the Executing State.

Brooks DeviceNet MFCs/MFMs

7.7.2.2. Valve Override¹

The following table outlines the valid valve override types.

Table 7-35 Valve Override Values

Value	State	Description
0	Normal	Valve is under normal operational control
1	Closed	Valve is driven fully closed
2	Open	Valve is driven fully open
3	Hold	Valve is held to last updated value prior to assertion of override
4	Safe State	Valve is driven to the condition specified by Safe State

7.7.3. Flow Control Group²

Table 7-36 Supported Flow Control Parameters

EDS Parameter	Values	Description	EPATH
Flow Control Data Type ^{3, 4}	Appendix B - Data Type Definitions	The data type associated with the value of Setpoint.	[0x33-1-3]
Flow Control Data Units	See "Volumetric Units Table" and "Mass Units Table" in Appendix C - Data Units	The engineering units associated with Setpoint.	[0x33-1-4]
Flow Control Constant Time Ramp Rate	0 to 86400000 msec	Sets the time the controller will take to move from the current position to the new setpoint position	[0x33-1-19]

¹ This Override action only occurs when the device is in the Executing State.

² Available for Mass Flow Controllers only.

³ This parameter is only configurable when the device is in the Idle State (i.e. when the device is not being actively scanned/pollled).

⁴ This parameter will automatically be set based upon the inferred data type of the selected Assembly used for I/O (i.e. if an Assembly is selected that contains Setpoint as one of its data members, and the inferred data type of the assembly is INT, then this attribute will be automatically set to INT once I/O data exchange begins).

7.7.4. Polled Connection Group

Table 7-37 Polled Connection Values

Parameter	Values	Description	EPATH
Poll Prod Assy ¹	See "Summary Table of Input Assemblies" -Appendix A -Assembly Object Detail	This parameter selects the Assembly the Polled I/O Connection will use to produce data	[0x5-2-100]
Poll Cons Assy ¹	See "Summary Table of Output Assemblies" -Appendix A -Assembly Object Detail	This parameter selects the Assembly that the Polled I/O Connection will use to receive data	[0x5-2-101]

7.7.5. Device Info Group

All values associated with this group are Read Only

Table 7-38 Supported Device Info Parameters

Parameter	Values	Description	EPATH
Device Type	"MFC" or "MFM"	The SEMI Standard specified name which identifies the Device Model used by this device	[0x30-1-3]
SEMI Standard Rev. Level	"E54-0997"	The revision level of the SEMI S/A Network Standard to which this device complies	[0x30-1-4]
Mfr. Name	"Brooks Instrument"	The name of the manufacturer of the device	[0x30-1-5]
Mfr. Model Number		The model number of the device assigned by Brooks Instrument	[0x30-1-6]
Software Rev		The firmware revision contained in the device	[0x30-1-7]
Hardware Rev.		The hardware revision of the electronics contained in the device	[0x30-1-8]
Mfr. Serial Number		The serial number assigned to the device by Brooks Instrument	[0x30-1-9]
Device Config		Any additional configuration information related to the device	[0x30-1-10]

¹ A power cycle or reset is required for the value of this attribute to take affect.

Brooks DeviceNet MFCs/MFMs

7.7.6. Soft Start (Ramp) Control Group ¹

These parameters are repeated for convenience from the Flow Control Group above.

Table 7-39 Supported Soft Start Parameters

Parameter	Values	Description	EPATH
Flow Control Constant Time Ramp Rate	0 to 86400000 msec	See Flow Control Group	[0x33-1-19]

7.7.7. Alarms/Warnings Group ¹

Table 7-40 Alarms/Warnings

Parameter	Values	Description	EPATH
Device Alarm On	True(=1) or False(=0)	Enables the reporting of individual object's alarms via the S-Device Supervisor object attributes Status[11] and Exception Detail Alarms[13].	[0x30-1-15]
Device Warning On	True(=1) or False(=0)	Enables the reporting of individual object's warnings via the S-Device Supervisor object attributes Status[11] and Exception Detail Warnings[14].	[0x30-1-16]
Flow Sensor Alarm On	True(=1) or False(=0)	Enables the reporting of alarms associated with the flow sensor via the S-Analog Sensor Object Instance one attribute Status[7]. Additionally, if the Device Alarms[15] are enabled these alarms will also be reported via the S-Device Supervisors Status[11] and Exception Detail Alarms[13].	[0x31-1-8]
Flow Sensor Warn On	True(=1) or False(=0)	Enables the reporting of warnings associated with the flow sensor via the S-Analog Sensor Object Instance one attribute Status[7]. Additionally, if the Device Warnings[16] are enabled these warnings will also be reported via the S-Device Supervisors Status[11] and Exception Detail Warnings[14].	[0x31-1-9]
Act. Alarm On	True(=1) or False(=0)	Enables the reporting of alarms associated with the actuator via the S-Analog Actuator Object attribute Status[7]. Additionally, if the Device Alarms[15] are enabled these alarms will also be reported via the S-Device Supervisors Status[11] and Exception Detail Alarms[13].	[0x32-1-8]
Act. Warn On	True(=1) or False(=0)	Enables the reporting of warnings associated with the actuator via the S-Analog Actuator Object attribute Status[7]. Additionally, if the Device Warnings[16] are enabled these warnings will also be reported via the S-Device Supervisors Status[11] and Exception Detail Warnings[14].	[0x32-1-9]

¹ Available for Mass Flow Controllers Only.

Table 7-40 Alarms/Warnings (continued)

Parameter	Values	Description	EPATH
Flow Ctrl. Alarm On	True(=1) or False(=0)	Enables the reporting of alarms associated with the flow controller via the S-Single State Controller Object Instance one attribute Status[10]. Additionally, if the Device Alarms[15] are enabled these alarms will also be reported via the S-Device Supervisors Status[11] and Exception Detail Alarms[13].	[0x33-1-11]
Flow Ctrl. Warn On	True(=1) or False(=0)	Enables the reporting of warnings associated with the flow controller via the S-Single State Controller Object Instance one attribute Status[7]. Additionally, if the Device Warnings[16] are enabled these warnings will also be reported via the S-Device Supervisors Status[11] and Exception Detail Warnings[14].	[0x33-1-12]

8. Glossary

This section is intended as a brief overview of DeviceNet terminology used throughout this manual.

Assembly

An Assembly is a Class that defines a collection of EPATH(s). This collection allows multiple attributes to be virtually accessed all at once. Each instance of an Assembly defines a unique set of EPATH(s).

Example:

The movement of data in an I/O type Connection is defined by the Produce and Consume Path attributes (see EPATH). Only one EPATH can be assigned to each of these attributes, thus limiting the amount of data that can be moved through an I/O type Connection. The solution to move more data through the I/O type Connection is to assign the Produce and Consume EPATH attributes of the Connection to "point" to an Assembly, which in turn contains multiple EPATH's.

Attribute

A Parameter or Data Item that may be read or written and is used for the purpose of configuration or is used to obtain information.

Example:

The attribute Data Units defines the engineering units flow will be reported in. The attribute Value indicates the current flow through the device. Attributes can be read/write or read only.

Baud Rate

The data rate, or speed, that the device will communicate. Setting the Baud Rate switch found on the top cover of the SLA5800 Series MFC/MFM will configure this. The choices are 125k, 250k, and 500k.

Class

A logical collection of related Attributes that define a particular function and/or behavior.

Example:

The class S-Analog Sensor contains information about configuring a sensor, the current status of the sensor, and/or the current value of what is being sensed.

Brooks DeviceNet MFCs/MFMs

Connection

A connection is a logical link between two devices by which messages are transferred. A device can have 1 or more simultaneous Connections. In most typical applications, data is exchanged using 1 Explicit Connection and 1 I/O Connection. The DeviceNet specification has defined a pre-configured set of Connections referred to as the Master/Slave (M/S) Connection Set.

Device Profile

A specification that defines a set of DeviceNet objects that uniquely represents a particular device of that type or class. The device profile can further define attributes, services, assemblies, etc. that a device must support to be considered part of that type or class of device. These profiles are found in the ODVA specification, Vol. 1. The SLA5800 Series MFC/MFM conforms to the MFC device profile.

EDS

The Electronic Data Sheet (EDS) is a specially formatted text description for a device that describes the I/O characteristics and configurable parameters that are accessible via the DeviceNet network. EDS files can be read by configuration software used to configure DeviceNet networks (ex: RsNetworx from Allen-Bradley)

EPATH (formerly known as PATH)

An EPATH is a unique identifier (sometimes referred to as a pointer) comprised of a Class ID, an Instance ID, and an Attribute ID. Some Classes have EPATH attributes that point to a particular data item. An example of this would be the Connection Class that contains two attributes, Produce Path and Consume Path. These attributes define where incoming data is sent to, and outgoing data comes from. I/O Connections make use of these two particular attributes.

Expected Packet Rate (EPR)

The EPR is an attribute in the Connection Class that defines the maximum amount of time (in msec) messages should be received by the Connection (implementation of this value is dependent upon the Connection type, Explicit or I/O, but the behavior is the same in all Connection types). If the time between received messages for that connection exceeds the EPR, the Connection times out. This may result in the Connection being released by the device.

Explicit Connection

An Explicit Connection dictates a request and response exchange between two devices. The device sending the request must get a response from the device receiving the request message. Embedded in the Explicit Message is information about the Class, Instance, Attribute, Service, and any service data needed to process the message. As a result, processing of Explicit Messages generally takes longer than I/O messaging. This is why Explicit Connections are typically used for commissioning/configuration.

I/O Connection

I/O Connections are used for the exchange of data only. How a device processes the data and/or responds with data via an I/O Connection is defined within the Produce and Consume Path attributes of the I/O Connection instance (See EPATH and Assembly above).

Instance

An instance of a Class is a particular invocation of a Class (sometimes referred to as an Object). An Instance of a Class is unique in describing the behavior for a particular kind of object. Each instance of the class contains the same set of attributes defined by the class. The uniqueness of the instance is defined by the attribute values.

Example:

Assume that a device contains two sensors, one to measure flow, the other to measure temperature. To access information about one or the other sensor, two Instances of the class *S-Analog Sensor* class would need to exist. Each sensor would have the same attribute set because they were both created from the class *S-Analog Sensor*, but the values in each attribute set would be unique to the sensor to describe flow or to describe temperature.

Example:

The class Connection contains information about configuring a Connection. With most kinds of DeviceNet devices, multiple Connections are established within a device to exchange information. In most cases one Explicit type Connection is created to configure the device, another I/O type Connection is created to transfer larger amounts of data. Each type of Connection is created from the Connection class. Each Connection has unique information in its Attribute set that defines the behavior of the Connection et. al. an Explicit type Connection or an I/O type Connection.

Brooks DeviceNet MFCs/MFMs

MAC ID

The Media Access Control Identifier, more commonly known as the network address of the device. Setting the MAC ID switches found on the top cover of the SLA5800 Series MFC/MFM will configure this address. The range of addresses is 0 to 63.

Master/Slave

Master/Slave refers to the relationship between one controlling device (Master) and one or more subordinate devices (Slaves). This is a typical application of a DeviceNet network where the Master has the capability to establish Connections with more than one Slave. The (Master) then sends to each Slave control data and receives from each (Slave) device status and/or operational data. An example would be a (Master) device sending a setpoint to one or more mass flow controllers (Slaves), and each controller would respond with flow data.

M/S Polled I/O Connection

The M/S Polled I/O Connection establishes a data exchange between Master and Slave devices whereby the Master device sends an I/O message with 0 or more data to a Slave device, and the Slave device must respond with 0 or more data bytes.

Polling

A request/response method of exchanging data.

Safe State (Safe Mode)

An operational mode or state that is considered "safe" whereby the normal controller process is shut down and mechanical and sensing mechanisms are placed in a safe condition.

Service

A service is a pre-defined action that a Class provides. The most commonly used services are used to configure the device such as Get Attribute (0x0E) or Set Attribute (0x10). Other types of services may directly affect the behavior of a Class (or Object) such as Reset (0x5), Stop (0x6), or Start (0x7). There are many more services not listed here and each Class specifies which Services it supports.

Scanning

A technique of exchanging data with devices on a network whereby the Master device (scanner) polls each device on a network sequentially, continuing through the list of all devices connected to the network before starting the process again.

Brooks DeviceNet MFCs/MFMs

*THIS PAGE WAS
INTENTIONALLY
LEFT BLANK*

Installation and Operation Manual

X-DPT-DeviceNet-SLA5800-SLAMf-Series-RevB-MFC-eng

Part Number: 541B190AAG

April, 2014

Brooks DeviceNet MFCs/MFMs

*THIS PAGE WAS
INTENTIONALLY
LEFT BLANK*

Brooks DeviceNet MFCs/MFMs

LIMITED WARRANTY

Seller warrants that the Goods manufactured by Seller will be free from defects in materials or workmanship under normal use and service and that the Software will execute the programming instructions provided by Seller until the expiration of the earlier of twelve (12) months from the date of initial installation or eighteen (18) months from the date of shipment by Seller. Products purchased by Seller from a third party for resale to Buyer ("Resale Products") shall carry only the warranty extended by the original manufacturer.

All replacements or repairs necessitated by inadequate preventive maintenance, or by normal wear and usage, or by fault of Buyer, or by unsuitable power sources or by attack or deterioration under unsuitable environmental conditions, or by abuse, accident, alteration, misuse, improper installation, modification, repair, storage or handling, or any other cause not the fault of Seller are not covered by this limited warranty, and shall be at Buyer's expense.

Goods repaired and parts replaced during the warranty period shall be in warranty for the remainder of the original warranty period or ninety (90) days, whichever is longer. This limited warranty is the only warranty made by Seller and can be amended only in a writing signed by an authorized representative of Seller.

BROOKS SERVICE AND SUPPORT

Brooks is committed to assuring all of our customers receive the ideal flow solution for their application, along with outstanding service and support to back it up. We operate first class repair facilities located around the world to provide rapid response and support. Each location utilizes primary standard calibration equipment to ensure accuracy and reliability for repairs and recalibration and is certified by our local Weights and Measures Authorities and traceable to the relevant International Standards.

Visit www.BrooksInstrument.com to locate the service location nearest to you.

START-UP SERVICE AND IN-SITU CALIBRATION

Brooks Instrument can provide start-up service prior to operation when required.

For some process applications, where ISO-9001 Quality Certification is important, it is mandatory to verify and/or (re)calibrate the products periodically. In many cases this service can be provided under in-situ conditions, and the results will be traceable to the relevant international quality standards.



CUSTOMER SEMINARS AND TRAINING

Brooks Instrument can provide customer seminars and dedicated training to engineers, end users and maintenance persons.

Please contact your nearest sales representative for more details.

HELP DESK

In case you need technical assistance,

Americas	 + (1) 888-554-FLOW
Europe	 +31 (0) 318 549-290
Asia	 +81 (0) 3-5633-7100

Due to Brooks Instrument's commitment to continuous improvement of our products, all specifications are subject to change without notice.

TRADEMARKS

Adobe Acrobat Adobe Systems, Inc.
Brooks Brooks Instrument, LLC
DeviceNet Open DeviceNet Vendors Association, Inc.
Labview National Instrument, Inc.
ODVA Open DeviceNet Vendors Association, Inc.



Brooks Instrument
407 West Vine Street
P.O. Box 903
Hatfield, PA 19440-0903 USA
T (215) 362 3700
F (215) 362 3745
E-Mail BrooksAm@BrooksInstrument.com
www.BrooksInstrument.com

Brooks Instrument
Neonstraat 3
6718 WX Ede, Netherlands
T +31 (0) 318 549 300
F +31 (0) 318 549 309
E-Mail BrooksEu@BrooksInstrument.com

Brooks Instrument
1-4-4 Kitasuna Koto-Ku
Tokyo, 136-0073 Japan
T +81 (0) 3 5633 7100
F +81 (0) 3 5633 7101
E-Mail BrooksAs@BrooksInstrument.com

